



上海永铭电子股份有限公司

规格书

Specification For Approval

客户 Customer: 代理商百硅专用 (汽车电子产品客户)
 日期 Date: 2026/03/25

品名 Item: 导电性高分子混合铝电解电容
 Conductive Polymer HYBRID Aluminum Electrolytic Capacitors

型号 Series: VHU (符合 AEC-Q200)

版本 Version : 00

物料号 Customer P/N : YM-25V470UF-10X10.5-CG-VHU

客户确认 Client Confirmed	
批准 Approved by	审核 Checked by

批准 Approved by		
批准 Approved by	审核 Checked by	拟制 Prepared by
孙涛	孙涛	上海永铭电子股份有限公司 固态事业部 业务专用章

承认书请寄回一份

Please Return One Copy with Your Approval

上海永铭电子股份有限公司

Shanghai Yongming Electronic Co., Ltd.

Tel: 021-33617848

Fax: 021-33617128

Http://www.sh-ymin.com

客户 Customer

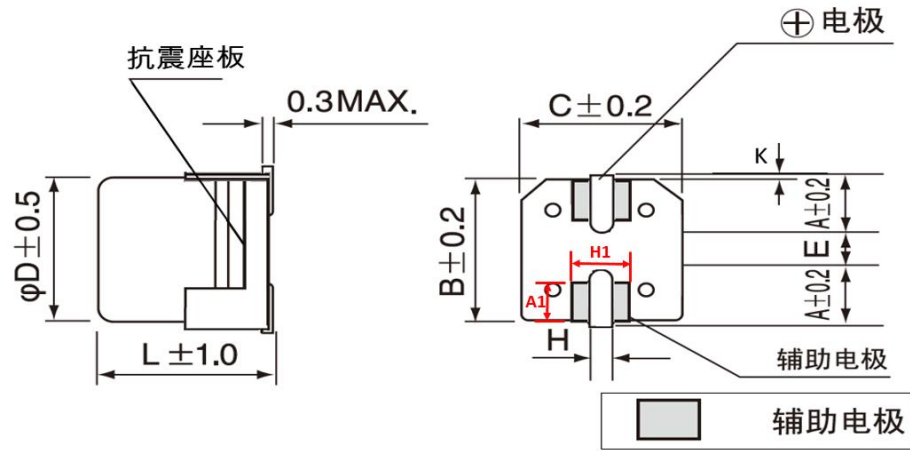
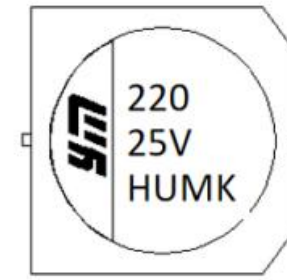

FIG-1



φ 6.3



φ 8~φ 10

φD	B	C	A	H	E	K	H1±0.2	A1±0.2
6.3	7.0	6.6	2.6	0.70±0.20	1.8	0.7MAX	2.8	1.3
8	8.9	8.5	3.0	0.90±0.20	3.1	0.7MAX	3.3	1.8
10	10.8	10.3	3.5	0.90±0.20	4.6	0.7MAX	3.8	1.8

TABLE-1

No	客户 物料编码 Customer Part No	永铭 物料编码 Ymin Part No	额定 电压 Rated Voltage (V.DC)	标称 容量 Cap (μF)	浪涌电压 Surge Voltage (V.DC)	工作温度范围 Operating Temp.Range (°C)	容量范围 Capacitance Tolerance	损耗 Tanδ 20±2°C 120Hz (% max)	等效串联电阻 ESR(Ω) 20±2°C 100KHz (Ω max)	纹波电流 Ripple Current 100KHz (mA)	漏电流 Leakage Current 20±2°C U _R , 2mins (μA max)	寿命 Load Life 135°C (Hours)	尺寸 Dimensions(mm)		
													φD	L	α
1	YM-25V470UF- 10X10.5-CG-VHU	VHUE1051E471MVKZNY	25	470	28.8	-55~+135	±20%	14	0.020	2000	117.5	4000	10	10.5	±1.0
2															
3															
4															
5															

5 产品特性 PRODUCT CHARACTERISTICS

5.1 电气特性 ELECTRICAL CHARACTERISTICS

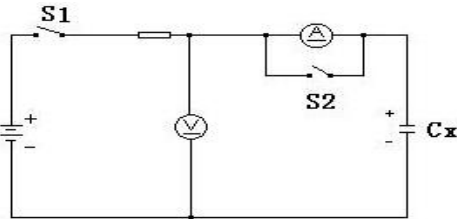
序号 NO	项目 Item	测试方法 Test method	性能 Performance
5.1.1	额定工作电压 Rated voltage		16~63 V.DC
5.1.2	电容量 Capacitance	测试频率: 120Hz±10% 测试电路: 串联等效电路 测试电压: 0.5Vrms Measuring frequency: 120Hz±10% Measuring circuit: Series equivalent circuit Measuring voltage: 0.5Vrms	见表 1 Refer to TABLE-1
5.1.3	损耗角正切值 Dissipation Factor	测试条件与 5.1.2 电容量测试相同 Testing condition are the same as 5.1.2 for capacitance	见表 1 Refer to TABLE-1
5.1.4	漏电流 Leakage current	<p>在电容器两端施加额定工作电压, 并串联 1000±100Ω电阻, 在施加电压 2 分钟后, 测量漏电流。 测试电路如下图:</p> <p>The rated voltage shall be applied across the capacitors and its protective resistor which shall be 1000±100Ω. The leakage current shall then be measured after an electrification period of 2 min.. Measurement circuit .</p>  <p>Rs: 保护电阻 (1000±100Ω) Rs: Protective resistor(1000±100Ω) V: 直流电压表 ; V: DC voltage meter A: 直流电流表; A: DC AM meter S₁: 开关 ; S₁:Switch S₂: 电流表保护开关 ; S₂:Protective switch for an ammeter</p> <p>备注: 漏电流测试, C.C 标准设定为 500mA.</p>	见表 1 Refer to TABLE-1

名称 Name

规格书 Specification

版本 Version

03

页数 Page

3

标准指南

Standard Manual

5.1.5	等效串联电阻 ESR	测试频率: 100kHz 测试温度: 20 ±2°C 测量位置: ESR测量时应夹取引线根部 Measuring frequency: 100kHz ; Measuring temperature: 20 ±2°C ; Measuring point : clamped at the root of the lead wire	Refer to TABLE-1
-------	---------------	---	-------------------------

5.2 机械特性 MECHANICAL PERFORMANCE

序号 NO	项目 Item	测试方法 Test method	特性 Performance
5.2.1	振动试验 Resistance to Vibration	依照AEC-Q200 频率范围:10~2000赫兹; 峰值加速度: 30g ; 方位:X、Y、Z; 12个周期/方向(共36个周期); 每个周期20分钟(总共12小时); To comply with AEC-Q200 Frequency range: 10~2000 Hz ; peak acceleration: 30g ; Orientation: X, Y, Z; 12 cycles/direction (total 36 cycles); 20 min for each cycle (total 12 hrs);	容量在30分钟内测量, 与初始值相比不应有较大的差异, 其改变在±5%以内 外观: 无可见机械损伤 Capacitance value should not show drastic change compared to the initial capacitance when the value is measured within 30 minutes. Prior to the completion of exam, capacitance change should be within ±5% compared to the initial value after the exam Appearance: No visible mechanical damage.
5.2.2	可焊性 Solder ability	温度: 235 ± 5 °C 持续时间: 2 ± 0.5秒 焊料:25wt%的松香(JIS K5902)//乙醇(JIS K 8101) Temperature : 235 ± 5 °C Duration : 2 ± 0.5 seconds Flux:Rosin (JIS K5902)//Ethanol(JIS K8101); About 25 wt.%	浸入焊锡的引线表面积约95%以上应附着新锡 At least 95% of surface area of the dipped portion of the terminal shall be covered with new solder.

5.3 耐久性测试 ENDURANCE PERFORMANCE

序号 NO	项目 Item	测试方法 Test method	特性 Performance
5.3.1	耐焊接热 Resistance to soldering heat	焊槽法: 焊锡温度: 260±5°C 浸入时间: 10±1 秒 外露引线长度不超过 1.0mm Solder bath method Solder temperature : 260±5°C Immersion time : 10±1sec. The exposed lead length shall not exceed 1.0mm	容量变化:在初始值的±5%以内 损耗角正切值:≤规定值的 130% 阻抗:≤规定值的 130% 漏电流:≤规定值 Variation of capacitance: Within ±5% of the initial value Dissipation factor: ≤ 130% of the specified value ESR: ≤ 130% of the specified value Leakage current: ≤ specified value
5.3.2	稳态湿热 Resistance to damp heat (steady state)	试验温度: 85±2°C 试验时间: 1000 (-0/+48)h 相对湿度: 85~90% R.H. 试验后, 电容器在标准大气条件下 1~2 小时, 然后测试参 数 Test temperature : 85±2°C Test time : 1000 (-0/+48) h Relative humidity: 85~90% R.H. After completion of test, the capacitors shall be subjected to standard atmospheric conditions for 1 to 2 hours, after which measurements shall be made.	电容变化在初始值的±30%内 损失角≤ 规格值的200% 等效串联电阻≤ 规格值的200% 漏电流≤规格值 Capacitance change within ±30% of initial value tan δ ≤ 200% of the initial specified value. ESR ≤ 200% of the initial specified value. Leakage current ≤initial specified value.
5.3.3	高温负荷试验 Load life test	试验温度: 135±2°C , 施加额定电压和额定纹波电流 Application of the rated voltage and the rated ripple current, Test temperature: 135±2°C	容量变化: 在初始值的±30%内; 损失角: 小于规格值的200%; 等效串联电阻≤规格值的200%; 漏电流≤规格值 ; 外观: 没有明显的损伤 Variation of capacitance: within ±30%of the initial value tan δ ≤ 200% of the initial specified value. ESR ≤ 200% of the initial specified value. Leakage current ≤ initial specified value. Appearance:No significant damage

名称	Name	规格书	Specification
版本	Version	03	5
		标准指南	Standard Manual

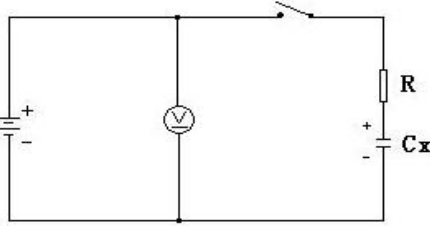

<p>5.3.4</p>	<p>快速变温 Rapid change of temperature</p>	<p>TA = 下限类别温度, TB = 上限类别温度; 在TA或TB的持续时间: 30分钟; TA与TB间转换时间: 1分钟之内; 循环次数: 1000次 (车规); 试验结束至少放置16小时, 或让电容恢复至20°C, 观察电容外观 及测量。 TA=Lower bound category temperature, TB=Upper limit category temperature; Duration in TA or TB: 30 minutes; Conversion time between TA and TB: Within a minute; Cycle number: 1000 Cycles the measurements shall be measured after 16 hours or restore the capacitor to 20°C</p>	<p>容量变化: 在初始值的±10%内 损失角: 小于或等于规格值 漏电流: 小于或等于规格值 Capacitance change : Within ±10% of the initial capacitance ; tanδ ≤ initial specified value. Leakage current : ≤ initial specified value.</p>																												
<p>5.3.5</p>	<p>耐浪涌电压 Surge Test</p>	<p>对电容施加额定浪涌电压, 充电 30±5 秒, 放电 5.5±0.5 分钟作为一个周期, 共进行 1000 次。测试回路如下图。然后在标准大气条件下放置达到热稳定, 测试各参数。测试温度: 15°C~35°C; Rated surge voltage shall be applied (switch on) for 30 seconds and then shall be applied (switch off) with discharge for 5min30 seconds at room temperature . This cycle shall be repeated for 1000 cycles . Duration of one cycle is 6 minutes . Test temperature: 15°C~35°C The test circuit is as follows:</p>  <p>浪涌电压设定 (Surge Voltage setting) :</p> <table border="1" data-bbox="443 1630 1072 1803"> <tr> <td>RV(V)</td> <td>6.3</td> <td>7.5</td> <td>10</td> <td>12</td> <td>16</td> <td>25</td> </tr> <tr> <td>S.V(V)</td> <td>7.2</td> <td>8.6</td> <td>11.5</td> <td>13.8</td> <td>18.4</td> <td>28.8</td> </tr> <tr> <td>RV(V)</td> <td>35</td> <td>50</td> <td>63</td> <td>80</td> <td>100</td> <td></td> </tr> <tr> <td>S.V(V)</td> <td>41</td> <td>58</td> <td>73</td> <td>92</td> <td>115</td> <td></td> </tr> </table>	RV(V)	6.3	7.5	10	12	16	25	S.V(V)	7.2	8.6	11.5	13.8	18.4	28.8	RV(V)	35	50	63	80	100		S.V(V)	41	58	73	92	115		<p>容量变化: 在初始值的±20%以内 损耗角正切值: ≤规定值的 150% 阻抗: ≤规定值的 150% 漏电流:≤规定值 Variation of capacitance: Within±20% of the initial value Dissipation factor: ≤150% of the specified value ESR: ≤150% of the specified value Leakage current: ≤specified value</p>
RV(V)	6.3	7.5	10	12	16	25																									
S.V(V)	7.2	8.6	11.5	13.8	18.4	28.8																									
RV(V)	35	50	63	80	100																										
S.V(V)	41	58	73	92	115																										



5.3.6	温度特性 Temperature Characteristic	<table border="1"> <thead> <tr> <th>阶段</th> <th>温度</th> <th>时间</th> </tr> </thead> <tbody> <tr> <td>1</td> <td>20±2℃</td> <td>30min</td> </tr> <tr> <td>2</td> <td>-55+0/-3℃(下限类别温度 T_B)</td> <td>120min</td> </tr> <tr> <td>3</td> <td>135+3/-0℃(上限类别温度 T_A)</td> <td>120min</td> </tr> </tbody> </table>	阶段	温度	时间	1	20±2℃	30min	2	-55+0/-3℃(下限类别温度 T _B)	120min	3	135+3/-0℃(上限类别温度 T _A)	120min	<table border="1"> <thead> <tr> <th>项目 Item</th> <th>性能 Performance</th> </tr> </thead> <tbody> <tr> <td>Z (-55℃) / Z (+20℃)</td> <td>≤2.5</td> </tr> <tr> <td>LC(+135℃) / LC (SPEC)</td> <td>≤25</td> </tr> </tbody> </table> <p>LC (SPEC) (μA) : 漏电流初始规格值 Initial specified value of Leakage Current</p>	项目 Item	性能 Performance	Z (-55℃) / Z (+20℃)	≤2.5	LC(+135℃) / LC (SPEC)	≤25																																																																										
阶段	温度	时间																																																																																													
1	20±2℃	30min																																																																																													
2	-55+0/-3℃(下限类别温度 T _B)	120min																																																																																													
3	135+3/-0℃(上限类别温度 T _A)	120min																																																																																													
项目 Item	性能 Performance																																																																																														
Z (-55℃) / Z (+20℃)	≤2.5																																																																																														
LC(+135℃) / LC (SPEC)	≤25																																																																																														
5.3.7	纹波电流 频率修正系数 frequency correction coefficient of Ripple current	<table border="1"> <thead> <tr> <th>静电容量 (C)</th> <th>频率 (f)</th> <th>100Hz≤f < 200Hz</th> <th>200Hz≤f < 300Hz</th> <th>300Hz≤f < 500Hz</th> <th>500Hz≤f < 1KHz</th> </tr> </thead> <tbody> <tr> <td>C < 47μF</td> <td rowspan="3">修正因子</td> <td>0.10</td> <td>0.10</td> <td>0.15</td> <td>0.20</td> </tr> <tr> <td>47μF≤C < 150μF</td> <td>0.15</td> <td>0.20</td> <td>0.25</td> <td>0.30</td> </tr> <tr> <td>150μF≤C</td> <td>0.15</td> <td>0.25</td> <td>0.25</td> <td>0.30</td> </tr> </tbody> </table> <table border="1"> <thead> <tr> <th>静电容量 (C)</th> <th>频率 (f)</th> <th>1KHz≤f < 2KHz</th> <th>2KHz≤f < 3KHz</th> <th>3KHz≤f < 5KHz</th> <th>5KHz≤f < 10KHz</th> </tr> </thead> <tbody> <tr> <td>C < 47μF</td> <td rowspan="3">修正因子</td> <td>0.30</td> <td>0.40</td> <td>0.45</td> <td>0.50</td> </tr> <tr> <td>47μF≤C < 150μF</td> <td>0.40</td> <td>0.45</td> <td>0.55</td> <td>0.60</td> </tr> <tr> <td>150μF≤C</td> <td>0.45</td> <td>0.50</td> <td>0.60</td> <td>0.65</td> </tr> </tbody> </table> <table border="1"> <thead> <tr> <th>静电容量 (C)</th> <th>频率 (f)</th> <th>10KHz≤f < 15KHz</th> <th>15KHz≤f < 20KHz</th> <th>20KHz≤f < 30KHz</th> <th>30KHz≤f < 40KHz</th> </tr> </thead> <tbody> <tr> <td>C < 47μF</td> <td rowspan="3">修正因子</td> <td>0.60</td> <td>0.65</td> <td>0.70</td> <td>0.75</td> </tr> <tr> <td>47μF≤C < 150μF</td> <td>0.70</td> <td>0.75</td> <td>0.80</td> <td>0.80</td> </tr> <tr> <td>150μF≤C</td> <td>0.75</td> <td>0.80</td> <td>0.85</td> <td>0.85</td> </tr> </tbody> </table> <table border="1"> <thead> <tr> <th>静电容量 (C)</th> <th>频率 (f)</th> <th>40KHz≤f < 50KHz</th> <th>50KHz≤f < 100KHz</th> <th>100KHz≤f < 500KHz</th> <th>500KHz≤f</th> </tr> </thead> <tbody> <tr> <td>C < 47μF</td> <td rowspan="3">修正因子</td> <td>0.80</td> <td>0.85</td> <td>1.00</td> <td>1.05</td> </tr> <tr> <td>47μF≤C < 150μF</td> <td>0.85</td> <td>0.90</td> <td>1.00</td> <td>1.00</td> </tr> <tr> <td>150μF≤C</td> <td>0.85</td> <td>0.90</td> <td>1.00</td> <td>1.00</td> </tr> </tbody> </table>						静电容量 (C)	频率 (f)	100Hz≤f < 200Hz	200Hz≤f < 300Hz	300Hz≤f < 500Hz	500Hz≤f < 1KHz	C < 47μF	修正因子	0.10	0.10	0.15	0.20	47μF≤C < 150μF	0.15	0.20	0.25	0.30	150μF≤C	0.15	0.25	0.25	0.30	静电容量 (C)	频率 (f)	1KHz≤f < 2KHz	2KHz≤f < 3KHz	3KHz≤f < 5KHz	5KHz≤f < 10KHz	C < 47μF	修正因子	0.30	0.40	0.45	0.50	47μF≤C < 150μF	0.40	0.45	0.55	0.60	150μF≤C	0.45	0.50	0.60	0.65	静电容量 (C)	频率 (f)	10KHz≤f < 15KHz	15KHz≤f < 20KHz	20KHz≤f < 30KHz	30KHz≤f < 40KHz	C < 47μF	修正因子	0.60	0.65	0.70	0.75	47μF≤C < 150μF	0.70	0.75	0.80	0.80	150μF≤C	0.75	0.80	0.85	0.85	静电容量 (C)	频率 (f)	40KHz≤f < 50KHz	50KHz≤f < 100KHz	100KHz≤f < 500KHz	500KHz≤f	C < 47μF	修正因子	0.80	0.85	1.00	1.05	47μF≤C < 150μF	0.85	0.90	1.00	1.00	150μF≤C	0.85	0.90	1.00	1.00
静电容量 (C)	频率 (f)	100Hz≤f < 200Hz	200Hz≤f < 300Hz	300Hz≤f < 500Hz	500Hz≤f < 1KHz																																																																																										
C < 47μF	修正因子	0.10	0.10	0.15	0.20																																																																																										
47μF≤C < 150μF		0.15	0.20	0.25	0.30																																																																																										
150μF≤C		0.15	0.25	0.25	0.30																																																																																										
静电容量 (C)	频率 (f)	1KHz≤f < 2KHz	2KHz≤f < 3KHz	3KHz≤f < 5KHz	5KHz≤f < 10KHz																																																																																										
C < 47μF	修正因子	0.30	0.40	0.45	0.50																																																																																										
47μF≤C < 150μF		0.40	0.45	0.55	0.60																																																																																										
150μF≤C		0.45	0.50	0.60	0.65																																																																																										
静电容量 (C)	频率 (f)	10KHz≤f < 15KHz	15KHz≤f < 20KHz	20KHz≤f < 30KHz	30KHz≤f < 40KHz																																																																																										
C < 47μF	修正因子	0.60	0.65	0.70	0.75																																																																																										
47μF≤C < 150μF		0.70	0.75	0.80	0.80																																																																																										
150μF≤C		0.75	0.80	0.85	0.85																																																																																										
静电容量 (C)	频率 (f)	40KHz≤f < 50KHz	50KHz≤f < 100KHz	100KHz≤f < 500KHz	500KHz≤f																																																																																										
C < 47μF	修正因子	0.80	0.85	1.00	1.05																																																																																										
47μF≤C < 150μF		0.85	0.90	1.00	1.00																																																																																										
150μF≤C		0.85	0.90	1.00	1.00																																																																																										

6. 标记 MARKING

6.1 在电容器体上清晰注明有如下内容：Capacitor shall be clearly marked on it' s body.

6.1.1 额定静容量 额定电容 Rated Capacitance

6.1.2 额定工作电压额定电压 Rated voltage

6.1.3 系列 Series

6.1.4 负极标示 Negative Polarity

6.1.5 生产日期 Date of production

6.1.6 系列编码 Series code



系列 series	VP1	VPX	VPT	VPL	VPH	VPM	VPG	VPS	VGY	VHU
	NP1	NPX	NPT	NPL	NPH	NPM	NPG	NPS	NGY	NHU
编码 code	P1	PX	PT	PL	PH	PM	PG	PS	GY	HU

6.1.7 年份编码 Year Code

年份 Year	2013	2014	2015	2016	2017	2018	2019	2020	2021	2022	...	2038
编码 Code	A	B	C	D	E	F	G	H	J	K	...	Z

6.1.8 月份编码 Month code

月份 Month	1	2	3	4	5	6	7	8	9	10	11	12
编码 Code	A	B	C	D	E	F	G	H	J	K	L	M

7. 包装 package

7.1 载带尺寸 Cartridge cassette (单位 Unit:mm):

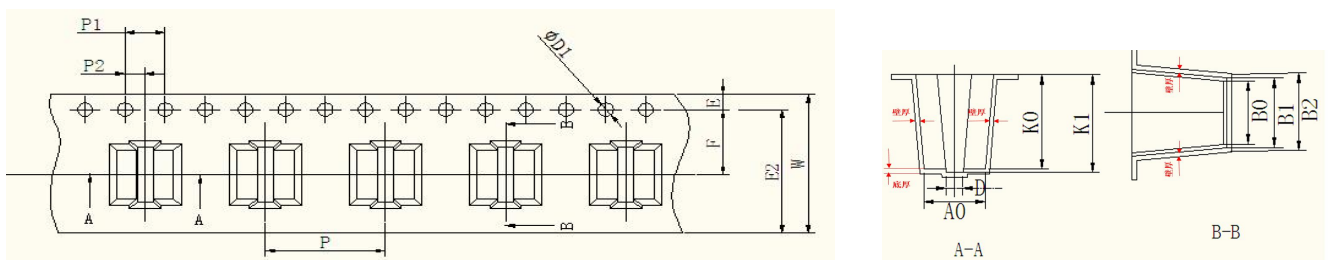

载带尺寸 Cartridge cassette	W	A0	B0	B1	B2	D	D1	E	F	K0	K1	P	t
	+0.1 -0.3	±0.1	±0.1	±0.1	±0.2	±0.1	+0.1 -0.0	±0.1	±0.1	±0.1	±0.1	±0.1	±0.05
/	/	/	/	/	/	/	/	/	/	/	/	/	/

7.2 料盘和包装数量 Taping Reel and Packing Quantity :

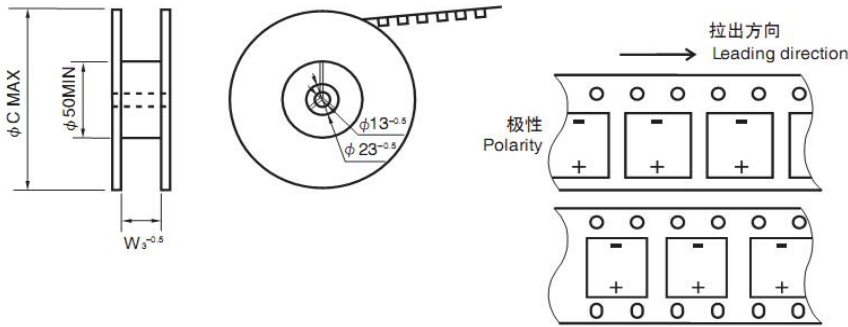

尺寸 Size	W3 (mm)	φ C (mm)	每卷数 量 pcs/roll	内盒 Inside Box		外箱 outer carton	
				料盘数 Rolls/Box	每盒数量 pcs / Box	内盒数量 Boxes/ Carton	每箱数量 pcs / Carton
Φ5*5.4~5.8	12	380	1200	8	9600	3	28800
Φ5*7.7~8.5	16	380	900	6	5400	3	16200
Φ5*9.5~10	16	380	700	6	4200	3	12600
Φ5*11~12	16	380	500	6	3000	3	9000
Φ5.5*15.5	16	380	350	5	1750	3	5250
Φ6.3*3.95~4.5	16	380	1500	6	9000	3	27000
Φ6.3*5.4~5.8	16	380	1200	6	7200	3	21600
Φ6.3*7.7 (8)	16	380	900	6	5400	3	16200
Φ6.3*8.5	16	380	800	6	4800	3	14400
Φ6.3*9.5~10	16	380	700	6	4200	3	12600
Φ6.3*11~13	16	380	500	6	3000	3	9000
Φ6.3*16	16	380	350	5	1750	3	5250
Φ8*5.7~6.9	24	380	800	5	4000	3	12000
Φ8*7.7~7.9	24	380	600	5	3000	3	9000
Φ8*8.5~10.5	24	380	500	5	2500	3	7500
Φ8*11~13.5	24	380	400	5	2000	3	6000
Φ8*14.5~18	24	380	350	5	1750	3	5250
Φ8*20.5	24	380	175	5	875	3	2625
Φ10*5.7~6.9	24	380	800	5	4000	3	12000
Φ10*7.5~8.5	24	380	600	5	3000	3	9000
Φ10*8.5~10.5	24	380	500	5	2500	3	7500
Φ10*12~14	24	380	400	5	2000	3	6000
Φ10*14.5~15	24	380	350	5	1750	3	5250
Φ10*16.5~18	24	380	350	5	1750	3	5250



8、产品编码规则

Product Code Rules

编码序号	1	2	3	4	5	6	7	8	9	10	11	12	13	14	15	16	17	18	19	20	21	22	1-22组合	
编码说明	产品系列 编码			直径 编码	高度 编码		额定工作电压 编码		额定容量 编码			容量范围 编码		引脚成型/编带 编码		丝印或套管 编码 注：车规可留空		应用类别 编码 注：消费类可留空		补充要求编码 未位1和未位2 注：可留空		客户定制编码 未位1和未位2 注：可留空		完整编码 示例
编码示例1	N	P	M	A	1	1	0	1	E	1	0	1	K	P	T	M	L	G	K	Z	H	H	NPMA1101E101KPTMLGKZHH	
编码示例2	V	P	X	C	0	5	8	1	V	1	0	1	M	V	T	M					H	H	VPXC0581V101MVTMHH	
编码示例3	V	H	X	C	0	5	8	1	V	1	0	1	M	V			C	G			7	T	VHXC0581V101MVCG7T	
编码示例4	N	P	X	L	2	5	0	1	K	2	2	2	M	J	J	G	J	P					NPXL2501K22MJGJP	

产品系列编码		额定容量编码				产品尺寸编码				容量范围编码	
系列	编码	容量	编码	容量	编码	直径	编码	高度	编码	容量范围	编码
NP1	NP1	1.0	1R0	180	181	3.55	W	3.55	035	±20%	M
NPX	NPX	1.5	1R5	220	21	4	A	3.95	039	±10%	K
NPH	NPH	2.2	2R2	270	271	4.5	G	4.5	045	引脚成型/编带编码	
NPT	NPT	2.7	2R7	330	331	5	B	5	050	F	引线 22F27F
NPL	NPL	3.3	3R3	390	391	5.5	H	5.4	054	A	切直脚 A 图
VP1	VP1	4.7	4R7	470	471	6.3	C	5.8	058	B	切脚成型 B 图
VPX	VPX	5.6	5R6	560	561	8	D	6.5	065	C	切脚成型 C 图
VPH	VPH	6.8	6R8	680	681	10	E	7	070	D	切脚成型 D 图
VPT	VPT	8.2	8R2	820	821	12.5	L	7.7	077	E	切脚成型 E 图
VPL	VPL	10	100	1000	102	16	I	8	080	Q	切脚折弯 90°F 图 A 型 (右)
额定工作电压编码		12	120	1200	122	18	J	8.5	085	P	切脚折弯 90°F 图 B 型 (左)
电压	编码	15	150	1500	152	20	N	9	090	X	切脚成型 G 图
2.0V	0D	18	180	1800	182	22	K	9.5	095	G	切脚双折弯 90°H 图 A 型 (右)
2.5V	0E	22	220	2000	202	25	M	10	100	R	切脚双折弯 90°H 图 B 型 (左)
4.0V	0G	27	270	2200	222	30	P	10.5	105	K	编带 A 图
6.3V	0J	33	330	2500	252			11	110	L	编带 B 图
6.8V	0A	39	390	2700	272			11.5	115	V	SMD
7.5V	0L	47	470	3300	332			12	120	J	固态引线型
10V	1A	56	560	3900	392			12.5	125	O	引线 30F/35F
12V	1B	68	680	4700	472			13	130	H	引线 33F/38F
16V	1C	82	820	5600	562			13.5	135	T	剪脚 (长短脚)
25V	1E	100	101	6800	682			14	140	丝印或套管编码	
20V	1D	120	121	8200	822			14.5	145	JG	套胶管
35V	1V	150	151	10000	103			15	150	TM	涂膜丝印
50V	1H									应用类别编码	
63V	1J							16	160	CG	车规
80V	1K							16.5	165	LG	雷管
100V	2A							17	170	JP	军品
125V	2B							18	180	GY	工业
160V	2C							19	190	特殊要求编码	
200V	2D							20	200	KZ	抗震
250V	2E							25	250	客户定制编码 (未位码 1 和未位码 2)	
								31.5	315	□□	客户定制码, 由客户指定
								35.5	355		

9、回流焊条件 Reflow soldering condition:

无铅型回流焊允许条件 Lead free type reflow soldering condition :

电容器表面温度在 T°C 以下;

电容器表面温度在 200°C 以上的时间不能超过 t 秒。

电容器表面温度在 T₁ °C 以上的时间 不可超过 t₁ 秒;

预热控制在 100°C ~ 200°C 180 秒以内。

Temperature at surface of capacitor should below T °C.

The time of the surface temperature of the capacitors above 200 °C cannot exceed t second.

The time of the surface temperature of capacitors above T₁ °C can not exceed t₁.

Preheat should be made between 100 °C ~ 200 °C and for maximum 180 seconds.

T (°C) ①	T ₁ (°C)	t (sec) ②	t ₁ (sec) ③	回流焊次数 Reflow cycle
250	230	60	30	1

① 峰值温度 Peak Temperature (°C)

② 超过 200°C 的时间 (MAX) Max time above 200 °C

③ 超过 T₁ 的时间 (MAX) Max time above T₁

出现超过允许条件的情况, 请联系我们。If other condition over maximum, please contact us.

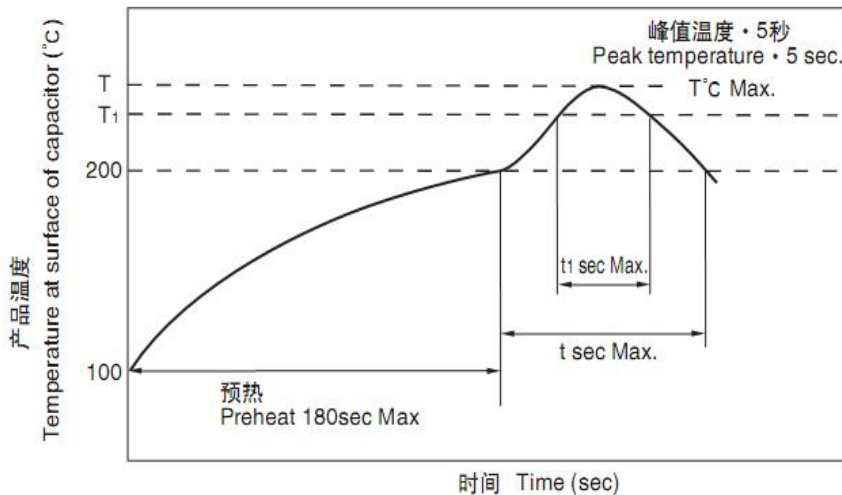

带辅助端子的抗振结构产品 Vibration proof packages with the supporting terminal.

对于外壳尺寸在φ8 以上的贴片型电容器, 可带有抗振结构。

当出现错焊时请进行手动重焊。此时, 请设定烙铁尖端温度为 380±10°C, 对电容器进行 3±0.5 秒的焊接。

For chip Aluminum electrolytic capacitors more than can size Φ8, vibration proof packages supports .

When there is mistake during soldering, please re-solder manually, the temperature of soldering iron should be set at 380±10 °C, and the soldering time on capacitor is 3 ±0.5 seconds.

名称	Name	规格书			Specification
版本	Version	03	页数	Page	11
标准指南		Standard Manual			

9.2 焊盘尺寸推荐 Recommended land pattern and size:

9.2.1 标准品焊盘尺寸:

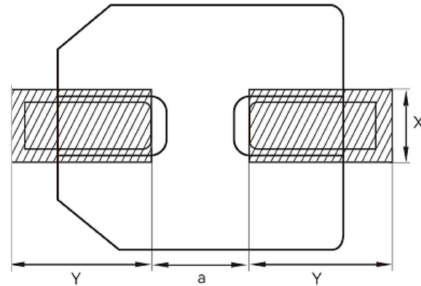

单位: mm

产品直径	标准品 焊盘尺寸		
	Y±0.10	a±0.10	X±0.10
φ4	2.60	1.00	1.60
φ5	3.00	1.40	1.60
φ6.3	3.50	1.90	1.60
φ8	4.20	3.10	2.20
φ10	4.40	4.00	2.30
φ12.5	5.70	4.00	2.50
φ16	6.90	6.00	2.50
φ18	7.90	6.00	2.50

9.2.2 耐震品焊盘尺寸:

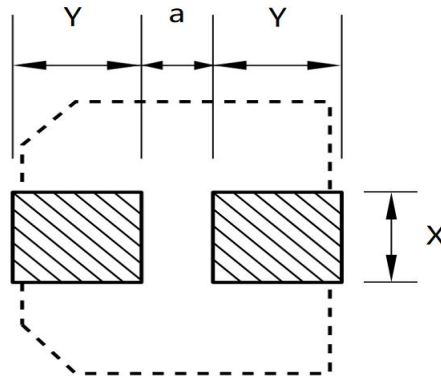

单位: mm

产品尺寸	抗震品 焊盘尺寸		
	Y±0.10	a±0.10	X±0.10
φ6.3	4.0	1.6	3.0
φ8	4.0	2.5	5.0
φ10	4.8	3.6	5.0
φ12.5	6.6	3.2	7.0
φ16	7.8	5.0	10.5
φ18	8.8	5.0	10.5

10. 其他 The others

10.1 铝电解电容器的应用上的重要信息

Important information on the application of Aluminun Electrolytic Capacitors .

10.1.1. 极性 Polarity

电容器是有极性的, 请勿施加反向电压或交流电压。极性接反会导致电容漏电流上升、甚至短路或防爆阀打开。电容器的极性确认, 请参见目录或产品规格中的相关图表, 或电容器本体上的极性标记。

Capacitors are polarized. Never apply a reverse voltage or AC voltage. Connecting with wrong polarity will short-circuit or damage the capacitor with the pressure relief vent opening early on. To identify the polarity of a capacitor, see the relevant diagram in the catalogs or product specifications, or the polarity marking on the body of the capacitors.

10.1.2. 施加电压 Operating voltage

电容器工作电压不应超过额定电压; 施加电压若超过额定电压, 将可能造成漏电流上升甚至短路;

电容器上设定了额定电压。请将和直流电压重叠的纹波电压的峰值设定在额定电压以下。

在工作温度范围内, 无论环境温度是多少度, 都可以在额定电压以下使用, 不需要降低电压。

Do not apply an over-voltage that exceeds a rated voltage specified for the capacitors. If the applied voltage

名称	Name	规格书			Specification
版本	Version	03	页数	Page	12
标准指南		Standard Manual			

exceeds the rated voltage, it may cause leakage current to rise or even short circuit.

The total peak value of the ripple voltage plus the DC voltage must not exceed the rated voltage of the capacitors. Capacitors do not require voltage derating within the category temperature.

10.1.3. 快速充放电 Rapid charge and discharge

常规电容器请勿使用于急速充放电的电路中。急速充放电可能造成电容短路、漏电增大及容量衰减，如果需要对电容进行高频次急速充放电或者高频次的深度充放电（短路放电和充），请联系我们。

Do not use conventional capacitors in circuits with rapid charge and discharge. Rapid charge and discharge may cause capacitor short circuit, increased leakage and capacity attenuation. If it is necessary to charge and discharge the capacitor rapidly at high frequency or deep charge and discharge at high frequency (short circuit discharge and charge), please contact us.

10.1.4. 存储电容器 Store the capacitors.

请保管在室温5 ~ 35°C、湿度75% 以下的环境。请尽量以包装状态保管。保管期限：原则上为制造后 2 年以内。

请避免在以下环境下保管：

- ① 溅水、高温高湿及结露的环境；
- ② 溅油、或者充满气体油成分的环境；
- ③ 溅盐水、充满盐分的环境；
- ④ 充满酸性有毒气体(硫化氢、亚硫酸、亚硝酸、氯、溴、溴；
- ⑤ 充满氨气等碱性有毒气体的环境；
- ⑥ 酸性及碱性溶剂的环境；
- ⑦ 直射阳光、臭氧、紫外线及放射线照射的环境。化甲烷等) 的环境；
- ⑧ 不可保管在使电容器受到振动、冲击的环境下；
- ⑨ 存放时间超过3年的电解电容器应报废处理；

Store the capacitors indoors at temperatures of 5 to 35°C and humidifies of less than 75%RH. In principle, aluminum electrolytic capacitors should be used within two years after production. Keep capacitors packed in the original packaging material wherever possible.

Avoid the following storage environmental conditions:

- ① Water spattering, high temperatures, high humidity or condensation environment.
- ② Oil spattering or oil mist filled.
- ③ Salt water spattering or salt filled.
- ④ Acidic toxic gases such as hydrogen sulfide, sulfuric acid, nitrous acid, chlorine, bromine and methyl bromide filled.
- ⑤ wyAlkaline toxic gases such as ammonium filled.
- ⑥ Acid or alkaline solutions spattering.
- ⑦ Direct sunlight, ozone, ultraviolet rays or radiation.
- ⑧ Extreme vibration or shock loading.
- ⑨ Electrolytic capacitors stored for more than 3 years shall be discarded.

10.1.5 纹波电流 Ripple current

请不要加载超大电流(超过额定纹波电流的电流)。

施加过大的纹波电流时，会使电容内部发热变大，温度上升，寿命变短甚至引起短路。

名称	Name	规格书			Specification
版本	Version	03	页数	Page	13
		标准指南	Standard Manual		

施加额定纹波电流时，请保持足够的直流偏置电压，避免造成反向电压的情况。

额定纹波电流的频率是100KHz，在其它频率下使用时，要控制在乘以各系列规定的频率修正系数的值以下。

Do not apply an over ripple current that exceeds the rated ripple current specified for the capacitors.. When excessive ripple current is applied, the internal heat generation of the capacitor will increase, the temperature will rise, and the life will be shortened. Even cause short circuit. When applying rated ripple current, please keep enough DC bias voltage to avoid reverse voltage. The frequency of rated ripple current is 100KHz, and when used at other frequencies, it should be controlled below the value multiplied by the frequency correction coefficient specified in each series.

10.1.6. 使用温度 Operating temperature

请不要在高温(超过工作上限温度的温度)下使用。如果超过工作上限温度使用，电容器的寿命会缩短，并可能导致压力阀动作等破损。

使用温度的关注内容不仅限于环境温度及机器内的温度，还需要确认电容附近的发热体(晶体管、电阻等)的辐射热、包括纹波电流自身发热等。如果使用温度降低，寿命会延长。

Please do not use the capacitors at high temperature (temperature exceeding the upper working limit). If it is used above the upper working temperature, the life of the capacitor will be shortened, which may lead to damage such as pressure valve operation. The attention of using temperature is not limited to the ambient temperature and the temperature in the machine, but also needs to confirm the radiant heat of the heating elements (transistors, resistors, etc.) near the capacitor, including the self-heating of ripple current, etc. If the service temperature is lowered, the service life will be prolonged.

10.1.7. 电容器的故障模式 Fault mode of capacitor

固体铝电解电容器是有使用寿命的零件，在一般情况下会表现为开路型故障模式。

产品及使用条件的不同有时会同时引发压力阀动作等的故障。

但是，在过电压或过电流等超过保证范围的负荷条件使用电容时，电容器也有可能发生短路模式故障。

电容器故障模式取决于导致故障的应用条件。

Aluminum electrolytic capacitor is a part with long service life, which usually shows an open-circuit failure mode. As well as the difference of product use conditions, sometimes faults such as pressure valve action will be caused at the same time. However, it also may lead to shot circuit mode failure when capacitor is used in the overload more than the guarantee ranges including over voltage and the over current. Failure modes depend on the application conditions that lead to fail.

10.1.8 电容器的绝缘

电容器的铝壳未保证绝缘。外部包装层作为标识之用，不保证电气绝缘功能；

电容器的外壳和阴极端子及阳极端子和电路型板请进行电气绝缘。

The can case of capacitor does not assure electrical insulation. The outer coating on can case is aimed for indication and does not assure function of the electrical insulation.

Electrically isolate the outer can case of a capacitor from the negative terminal, the positive terminal and circuit patterns.

10.1.9 焊接和安装 soldering and Assembling

焊接条件要在承认书的规定范围内。若没有遵守承认书的条件，则电容漏电流可能急剧增加，容量衰减。

名称	Name		规格书	Specification	
版本	Version	03	页数	Page	14
标准指南		Standard Manual			

安装注意事项:

- ①已经成套组装并通过电的电容器请勿再次使用;
- ②铝电解电容器可能存在一定的再生电压, 因此电容器使用前请用1kΩ左右的电阻器进行放电处理 ;
- ③在超过室温35℃、湿度75%RH 的条件下, 超过产品目录或规格说明书的规定期限进行长期保管时, 电容器的漏电流有可能增大。此时, 请对电容器进行电压处理 (105℃ , 额定电压及串联1 kΩ电阻保护, 充电2小时);
- ④安装前请确认电容器的额定规格(静电容量及额定电压);
- ⑤安装前请确认电容器的极性;
- ⑥请勿使用跌落过电容器;
- ⑦安装时请勿使电容器变形;
- ⑧安装前请确认电容器的端子间隔和印刷线路板的孔间距尺寸一致;
- ⑨机器设备自动化生产过程中, 电容器在吸附、装配及位置对准时, 或者对电容器引线进行加工时, 电容器有可能受到超出允许范围的应力, 请控制电容器受到的外力。

The soldering conditions are to be within the range prescribed in specifications. If the specifications are not followed, there is a possibility of the cosmetic deflection, the intensive increase of leakage current, and the capacitance reduction.

Precautions for Assembling:

- ① Do not reuse the capacitors that have been assembled in complete sets and passed electricity;
- ② The aluminum electrolytic capacitor may have a certain regeneration voltage, so please use a resistor of 1kw to discharge the capacitor before use;
- ③ The leakage current of the capacitor may increase when it is stored for a long time beyond the specified time limit in the catalogue or specification under the conditions of exceeding room temperature 35℃ and humidity 75%RH. At this time, please conduct voltage treatment on the capacitor. (105℃, rated voltage and 1 kΩ resistance protection in series, charging for 2 hours) .
- ④ Please confirm the rated specifications (electrostatic capacity and rated voltage) of the capacitor before installation;
- ⑤ Please confirm the polarity of the capacitor before installation;
- ⑥ Do not use dropped capacitors;
- ⑦ Do not deform the capacitor during installation;
- ⑧ Before installation, please confirm that the terminal spacing of capacitor is consistent with the hole spacing of printed circuit board.
- ⑨ During the automatic production of machinery and equipment, when the capacitor is adsorbed, assembled and aligned, or when the capacitor leads are processed, the capacitor may be stressed beyond the allowable range. Please control the external force on the capacitor.

焊接后处理Handling after soldering :

印刷配线板焊接后的处理注意不可施加以下机械应力:

- ①电容器主体不可倾斜、倒地或扭曲;
- ②不可抓住电容器的主体搬运电路板;
- ③不可让其他物体碰撞到电容器。此外, 当重叠放置印刷配线板时, 不可使印刷配线板或其他零件碰到电容器。
- ④安装好电容器的印刷电路板不可掉落;

Handling after soldering after welding: Pay attention to the treatment of printed wiring board after welding.

Do not apply the following mechanical stress:

名称	Name	规格书		Specification
版本	Version	03	页数	Page 15
		标准指南	Standard Manual	

- ① the capacitor body shall not tilt, fall to the ground or twist;
- ② Do not grasp the main body of the capacitor to carry the circuit board;
- ③ Do not let other objects collide with the capacitor. In addition, when the printed wiring boards are placed on top of each other, the printed wiring boards or other parts must not touch the capacitors.
- ③ Printed circuit boards with capacitors installed shall not fall off;

10.1.10 电容器的废弃处理

废弃电容器时，请交给专业的工业废弃物处理厂进行处理。

此外，为了防止电容器爆炸，请在电容器上开孔或者充分碾碎之后焚烧。

Disposal of capacitors. When the capacitor is discarded, please hand it over to a professional industrial waste treatment plant for treatment. In addition, in order to prevent the capacitor from exploding, please open a hole in the capacitor or burn it after being fully crushed.

10.2. 关于AEC-Q200

我公司可以按照要求提供铝电解电容器的基于AEC-Q200标准的试验结果。

电子零部件制造商无法单纯的判断「AEC-Q200认定」。因此我司会针对对象产品，做出「基于」、「符合」、「可使用」等说法的判断。

详情请另外咨询。

We can provide the test results of aluminum electrolytic capacitors based on AEC-Q200 standard as required. Electronic component manufacturers cannot simply judge "AEC-Q200 certification". Therefore, We will make judgments on the statements of "based on", "conforming" and "usable" for the target products.

Please consult separately for details.

10.3 环境有害物质的对应Response to the Substances of Concern

我司铝电解电容产品符合RoHs指令、REACH法规 以及无卤。

Our aluminum electrolytic capacitors comply with RoHs REACH and HF.

名称	Name		规格书	Specification	
版本	Version	03	页数	Page	16
标准指南			Standard Manual		