

### ■ Features

- Wide Bandgap SiC MOSFET Technology.
- Low On-Resistance with High Blocking Voltage.
- Low Capacitances with High-Speed Switching.
- Low Reverse Recovery (Qrr).
- Easy to Parallel and Simple to Drive.
- Robust against Parasitic Turn on Even 0V Turn off Gate Voltage.

### G3 MOSFET Technology

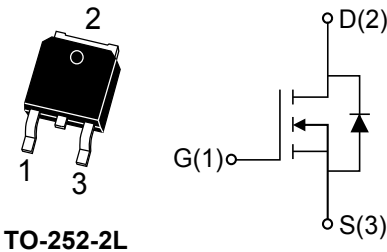
Parameter	Value	Unit
$V_{DS}$	650	V
$R_{DS(on)}_{typ@VGS=18V}$	160	mΩ
$I_{D@VGS=15V,TC=25^{\circ}C}$	17	A

### ■ Benefits

- Reduced Switching Losses.
- Increased System Switching Frequency.
- Increased Power Density.
- Reduction of Heat Sink Requirements.
- Reduced EMI.

### ■ Application

- Switch Mode Power Supplies.
- High Voltage DC/DC Converters.
- Battery Chargers.
- Motor Drives.
- Pulsed Power Applications.



TO-252-2L



### Maximum ratings( $T_j=25^{\circ}C$ , Unless otherwise specified)

Parameter	Symbol	Test Condition	Value	Unit
Drain to Source Voltage	$V_{DS,max}$	$V_{GS}=0V, I_D=500\mu A$	650	V
Gate to Source Voltage	$V_{GS,max}$	Absolute Maximum Values	-8/+20	V
Recommended Operation Voltage of Gate to Source	$V_{GS,op}$	Recommended Operational Values	-5...0/+15	V
Continuous Drain Current	$I_D$	$V_{GS}=15V, TC=25^{\circ}C$	17	A
		$V_{GS}=15V, TC=100^{\circ}C$	12	A
Pulsed Drain Current	$I_{D(pulsed)}$	$V_{GS}=15V, TC=25^{\circ}C$	43	A
Power Dissipation	$P_{tot}$	$TC=25^{\circ}C, T_j=175^{\circ}C$	62	W
Operating and Storage Temperature	$T_j, T_{stg}$	—	-55 to+175	$^{\circ}C$
Solder Temperature, 1.6mm from case for 10s	$T_L$	—	260	$^{\circ}C$



## Thermal Characteristics

Parameter	Symbol	Value			Unit
		Min	Typ	Max	
Thermal Resistance from Junction to Case	$R_{\theta JC}$	—	2.4	—	$^{\circ}C/W$

## Electrical Characteristics

### Static Characteristics

Parameter	Symbol	Test Condition	Value			Unit
			Min	Typ	Max	
Gate Threshold Voltage	$V_{GS(th)}$	$V_{GS}=V_{DS}, I_D=2mA, T_j=25^{\circ}C$	2.4	3.2	4	V
		$V_{GS}=V_{DS}, I_D=2mA, T_j=175^{\circ}C$	—	2.4	—	V
Drain to Source Breakdown Voltage	$V_{(BR)DSS}$	$V_{GS}=0V, I_D=500\mu A$	650	—	—	V
Zero Gate Voltage Drain Current	$I_{DSS}$	$V_{GS}=0V, V_{DS}=650V, T_j=25^{\circ}C$	—	—	10	$\mu A$
Gate to Source Leakage Current	$I_{GSS+}$	$V_{GS}=20V, V_{DS}=0V, T_j=25^{\circ}C$	—	—	50	nA
	$I_{GSS-}$	$V_{GS}=-8V, V_{DS}=0V, T_j=25^{\circ}C$	—	—	-50	nA
Drain to Source on Resistance	$R_{DS(on)}$	$V_{GS}=15V, I_D=7A, T_j=25^{\circ}C$	—	190	268	$m\Omega$
		$V_{GS}=15V, I_D=7A, T_j=175^{\circ}C$	—	230	—	$m\Omega$
		$V_{GS}=18V, I_D=7A, T_j=25^{\circ}C$	—	160	220	$m\Omega$
		$V_{GS}=18V, I_D=7A, T_j=175^{\circ}C$	—	200	—	$m\Omega$
Transconductance	$g_{fs}$	$V_{DS}=20V, I_{DS}=7A, T_j=25^{\circ}C$	—	6.2	—	S
		$V_{DS}=20V, I_{DS}=7A, T_j=175^{\circ}C$	—	5.6	—	S



### Electrical Characteristics

#### Dynamic Characteristics

Parameter	Symbol	Test Condition	Value			Unit
			Min	Typ	Max	
Input Capacitance	$C_{iss}$	VGS=0V, VDS=400V, f=1MHz, VAC=25mV	—	448	—	pF
Output Capacitance	$C_{oss}$		—	44	—	pF
Reverse Transfer Capacitance	$C_{rss}$		—	2.2	—	pF
Reverse Transfer Capacitance	$E_{oss}$	VGS=0/15V, VDS=400V, ID=7A, Tj=25°C	—	2.8	—	μJ
Gate-Source Charge	$Q_{gs}$		—	4.6	—	nC
Gate-Drain Charge	$Q_{gd}$		—	3.8	—	nC
Total Gate Charge	$Q_g$	VAC=25mV, f=1MHz	—	12.6	—	nC
Gate Resistance	$R_g$		—	7	—	Ω

#### Switching Characteristics

Parameter	Symbol	Test Condition	Value			Unit
			Min	Typ	Max	
Turn-On Delay Time	$t_{d(on)}$	VGS=0/15V, VDD=400V, ID=7A, RG(ext)=2.5Ω, RL=80Ω	—	11	—	ns
Rise Time	$t_r$		—	8.6	—	ns
Turn-Off Delay Time	$t_{d(off)}$		—	18.2	—	ns
Fall Time	$t_f$		—	14.6	—	ns
Turn-On Switching Energy	$E_{on}$	VDS=400V, VGS=0V/15V ID=7A, RG(ext)=2.5Ω, L=100μH	—	24	—	μJ
Turn-Off Switching Energy	$E_{off}$		—	16	—	μJ

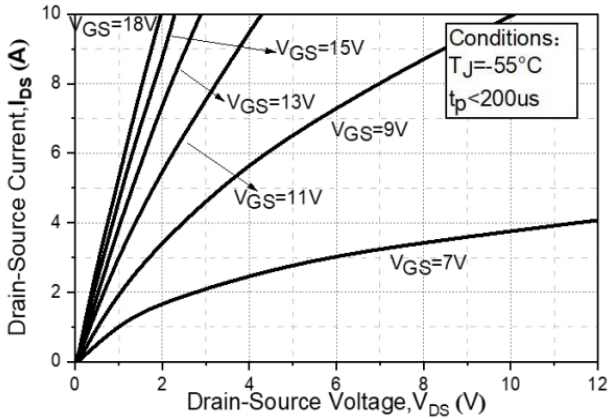
#### Reverse Diode Characteristics

Parameter	Symbol	Test Condition	Value			Unit
			Min	Typ	Max	
Diode Forward Voltage	$V_{SD}$	VGS=-5V, ISD=3.5A, Tj=25°C	—	4.7	—	V
		VGS=-5V, ISD=3.5A, Tj=175°C	—	3.6	—	V
Continuous Diode Forward Current	$I_S$	VGS=0V, Tj=25°C	—	—	16	A
Reverse Recovery Time	$t_{rr}$	VGS=0V, ISD=3.5A, VR=400V, Tj=25°C	—	12	—	ns
Reverse Recovery Charge	$Q_{rr}$		—	28	—	nC
Peak Reverse Recovery Current	$I_{rrm}$		—	1.8	—	A

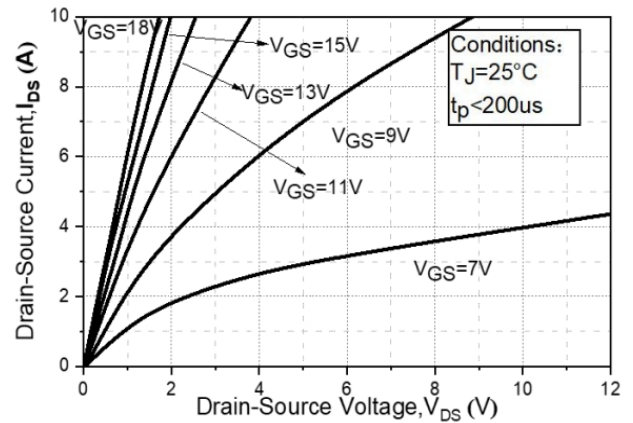


**Typical Performance**

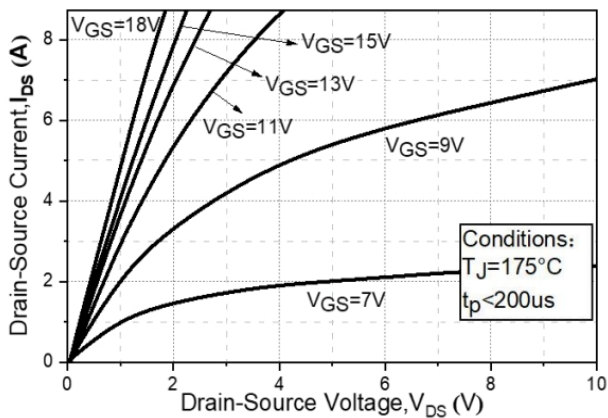
**Fig1. Output Characteristics  $T_J = -55^\circ\text{C}$**



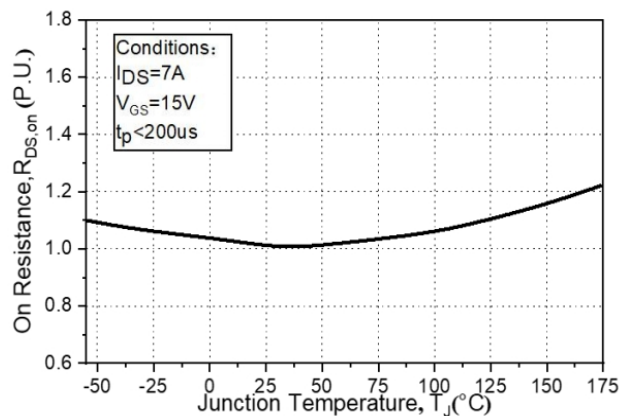
**Fig2. Output Characteristics  $T_J = 25^\circ\text{C}$**



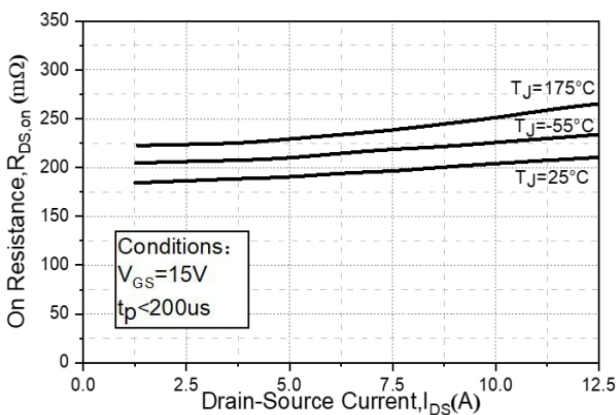
**Fig3. Output Characteristics  $T_J = 175^\circ\text{C}$**



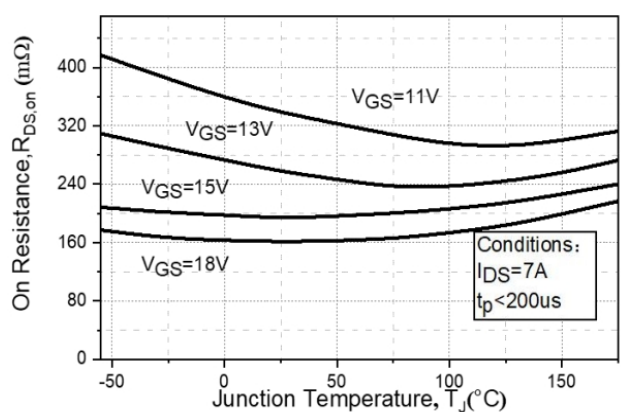
**Fig4. Normalized On-Resistance vs. Temperature**



**Fig5. On-Resistance vs. Drain Current For Various Temperatures**

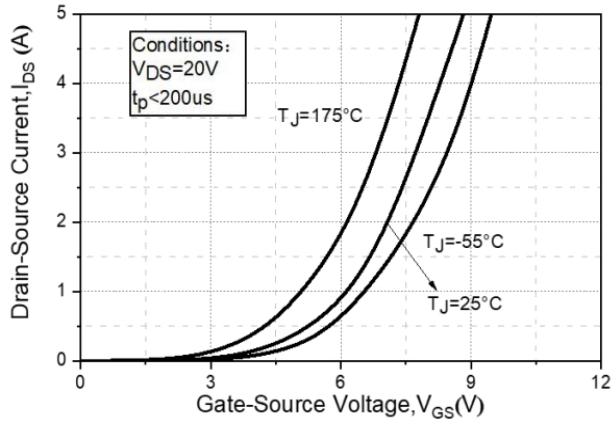


**Fig6. On-Resistance vs. Temperature For Various Gate Voltage**

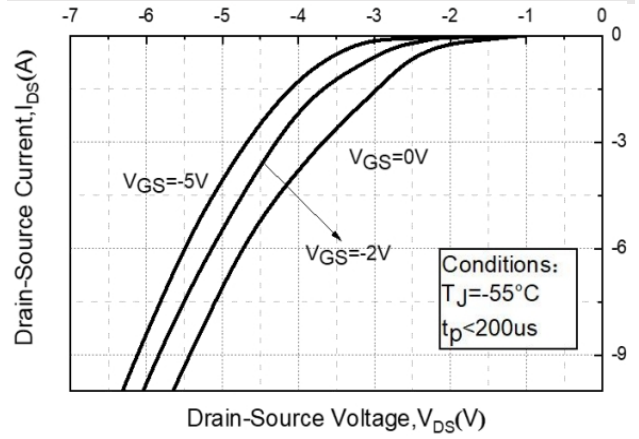


**Typical Performance**

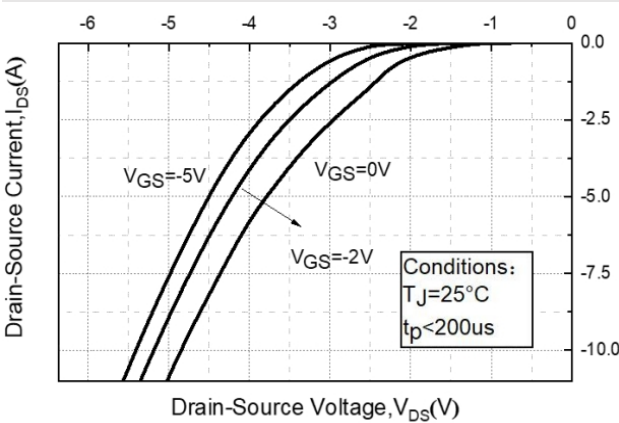
**Fig7. Transfer Characteristic for Various Junction Temperatures**



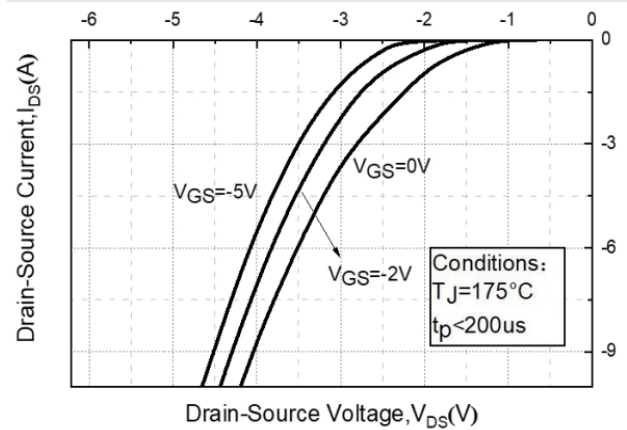
**Fig8. Body Diode Characteristic at  $-55^\circ\text{C}$**



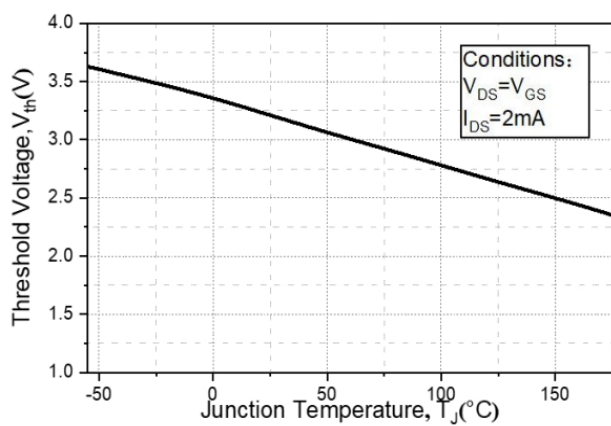
**Fig9. Body Diode Characteristic at  $25^\circ\text{C}$**



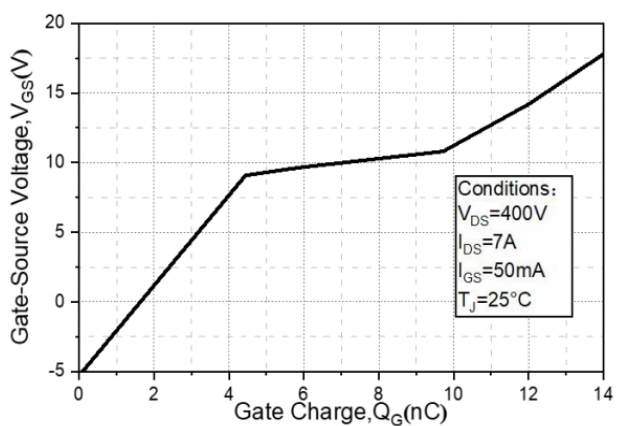
**Fig10. Body Diode Characteristic at  $175^\circ\text{C}$**



**Fig11. Threshold Voltage vs. Temperature**

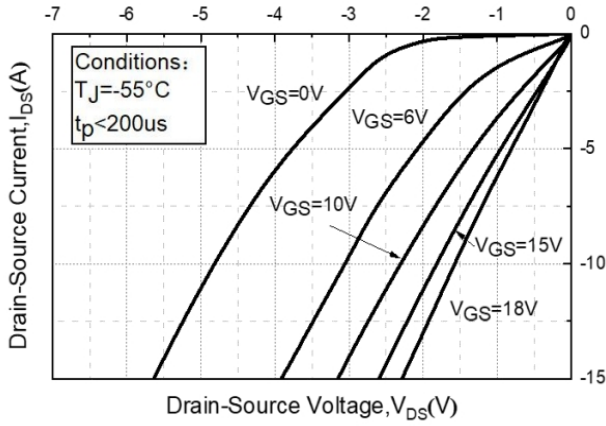


**Fig12. Gate Charge Characteristics**

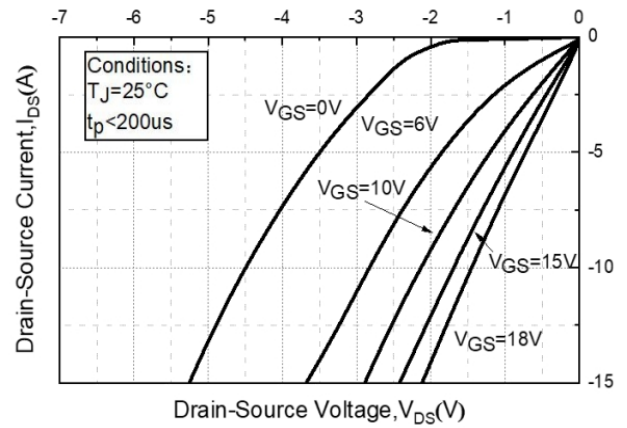


**Typical Performance**

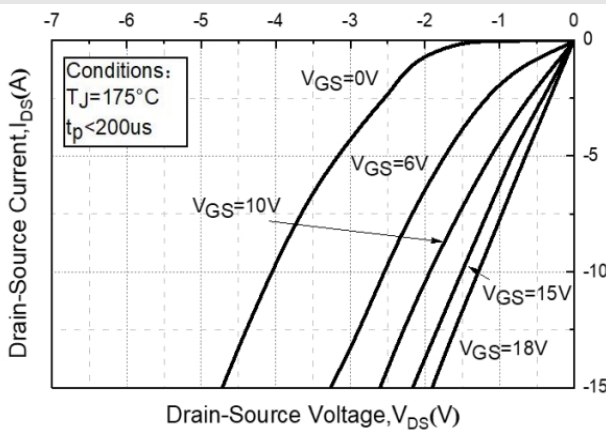
**Fig13. 3rd Quadrant Characteristic at -55°C**



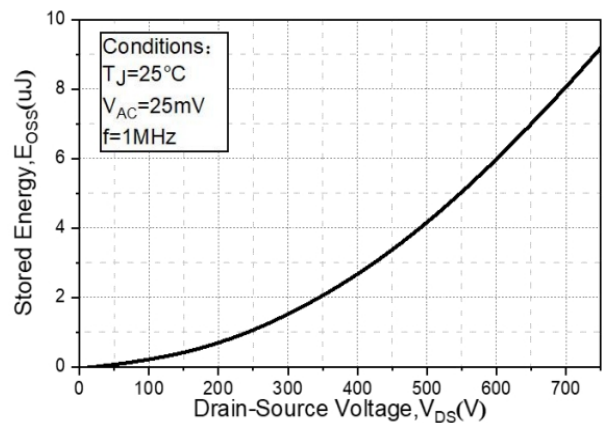
**Fig14. 3rd Quadrant Characteristic at 25°C**



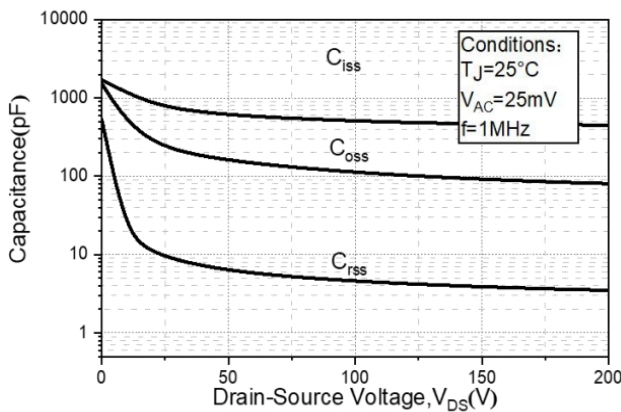
**Fig15. 3rd Quadrant Characteristic at 175°C**



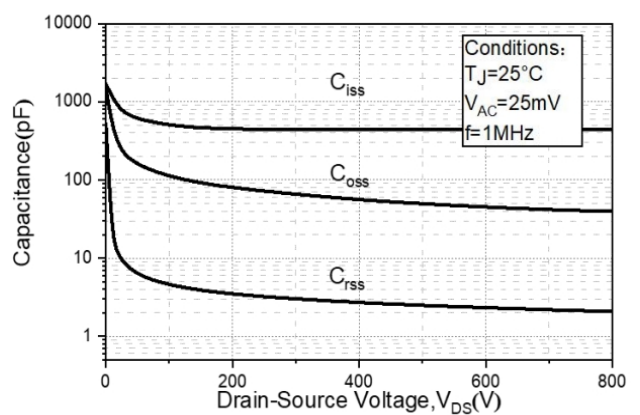
**Fig16. Output Capacitor Stored Energy**



**Fig17. Capacitances vs. Drain-Source Voltage (0-200V)**

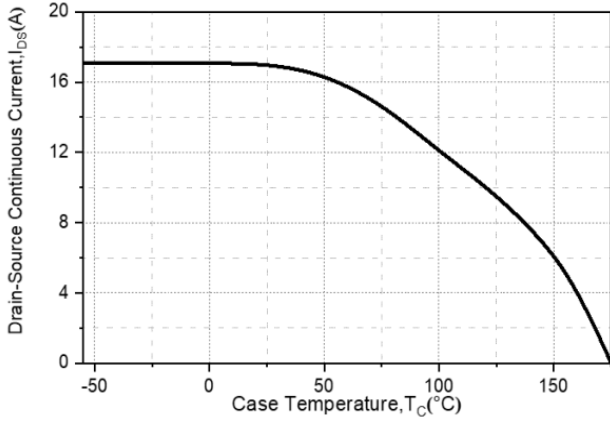


**Fig18. Capacitances vs. Drain-Source Voltage (0-800V)**

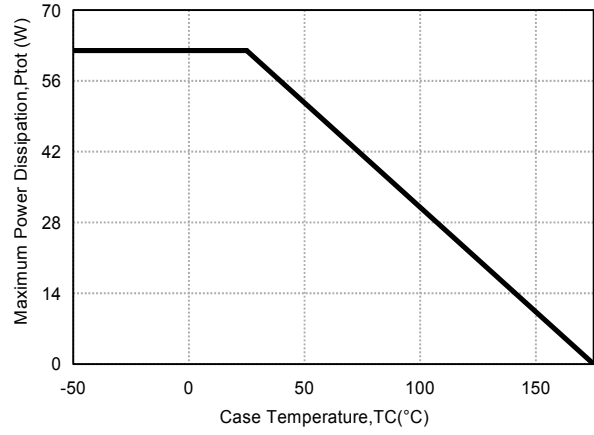


**Typical Performance**

**Fig19. Continuous Drain Current vs. Case Temperature**

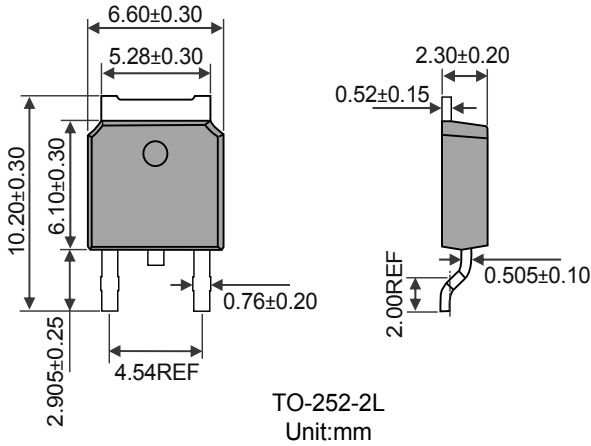


**Fig20. Maximum Power Dissipation vs. Case Temperature**

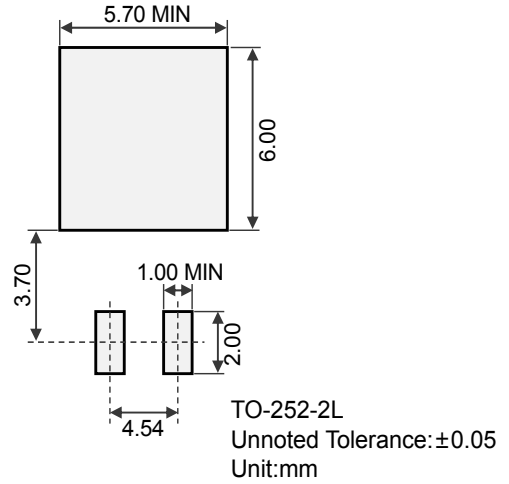


## Package Outline Dimensions & Suggested Solder Pad Layout

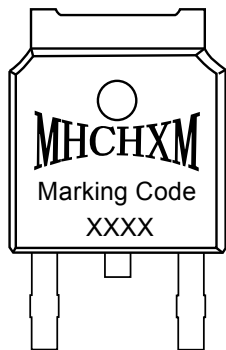
Package Outline Dimensions



Suggested Solder Pad Layout



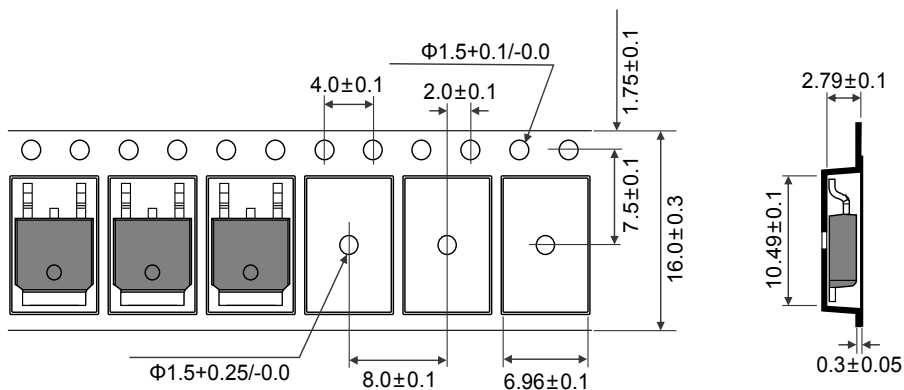
## Marking Information



“MHCHXM”= Product Logo  
 “Marking Code”= The Following  
 “XXXX”= Date Code Marking

Marking Code	Part Number
C65N160S3	HXMC65N160S3

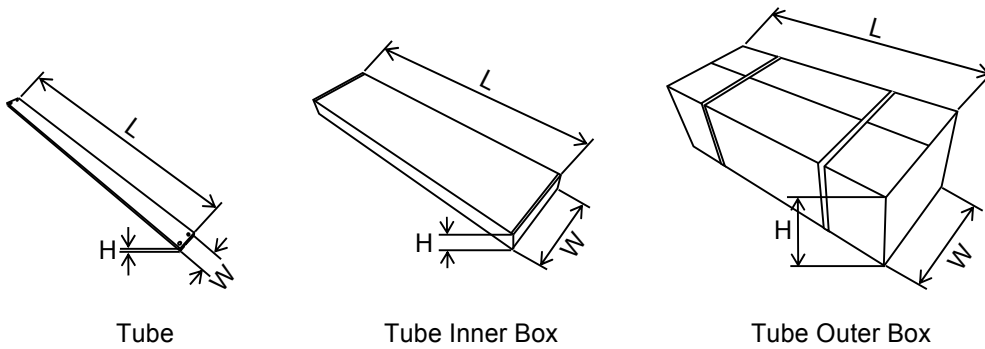
## Reel Tape Dimensions (Dimensions in mm)



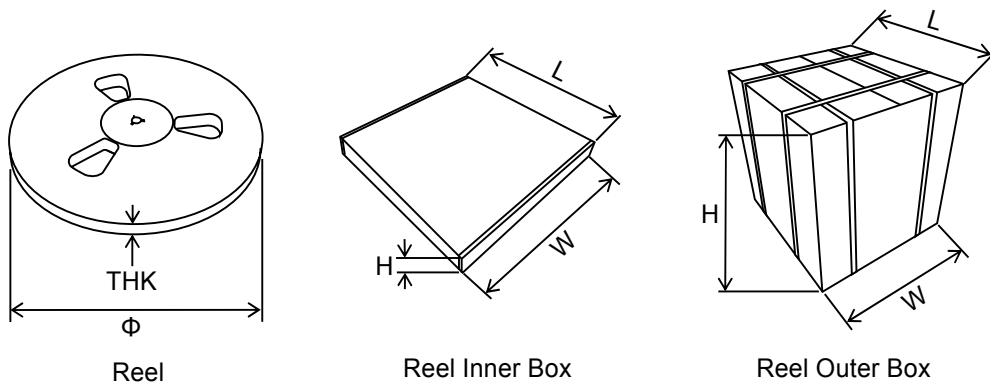
**Packing Information**

Packaging	Part Number	Quantity(pcs)	Size(mm)
Tube	Tube	80	L540×W20×H5
	Inner Box	4000	L570×W115×H55
	Outer Box	20000	L595×W320×H135
Reel	Reel	3000	Φ330×THK17
	Inner Box	3000	L350×W340×H25
	Outer Box	30000	L355×W300×H360

**Packaging:Tube**



**Packaging:Reel**



## DISCLAIMER

1. Above specification may be changed without notice. MHCHXM will reserve authority on material change for above specification.

2. The graphs shown in this datasheet are representing typical data only and do not show guaranteed values.

3. When using this product, please observe the absolute maximum ratings and the instructions for use outlined in these specification sheets. MHCHXM assumes no responsibility for any damage resulting from use of the product which does not comply with the absolute maximum ratings and the instructions included in these specification sheets.

4. These specification sheets include materials protected under copyright of MHCHXM. Reproduction in any form is prohibited without the specific consent of MHCHXM.

5. This product is not intended to be used for military, aircraft, automotive, medical, life sustaining or life saving applications or any other application which can result in human injury or death. Please contact authorized MHCHXM sales agent for special application request.

6. Statements regarding the suitability of products for certain types of applications are based on MHCHXM's knowledge of typical requirements that are often placed on MHCHXM products in generic applications. Such statements are not binding statements about the suitability of products for a particular application. It is the customer's responsibility to validate that a particular product with the properties described in the product specification is suitable for use in a particular application. Parameters provided in datasheets and/or specifications may vary in different applications and performance may vary over time. All operating parameters, including typical parameters, must be validated for each customer application by the customer's technical experts. Product specifications do not expand or otherwise modify MHCHXM's terms and conditions of purchase, including but not limited to the warranty expressed therein.

7. This publication supersedes & replaces all information previously supplied. For additional application information, please visit our website <http://www.jshxm.com>, or consult your nearest MHCHXM's sales office for further assistance.

