

### ■ Features

- Wide Bandgap SiC MOSFET Technology.
- Low On-Resistance with High Blocking Voltage.
- Low Capacitances with High-Speed Switching.
- Low Reverse Recovery (Qrr).
- Easy to Parallel and Simple to Drive.
- Robust against Parasitic Turn on Even 0V Turn off Gate Voltage.

### G3 MOSFET Technology

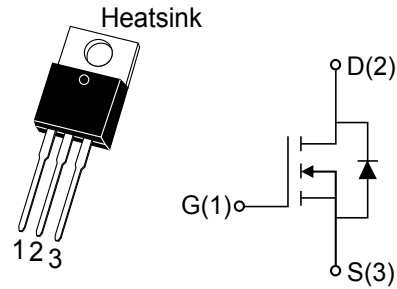
Parameter	Value	Unit
$V_{DS}$	650	V
$R_{DS(on)}_{typ@VGS=18V}$	160	mΩ
$I_{D@VGS=15V,TC=25^{\circ}C}$	17	A

### ■ Benefits

- Reduced Switching Losses.
- Increased System Switching Frequency.
- Increased Power Density.
- Reduction of Heat Sink Requirements.
- Reduced EMI.

### ■ Application

- Switch Mode Power Supplies.
- High Voltage DC/DC Converters.
- Battery Chargers.
- Motor Drives.
- Pulsed Power Applications.



TO-220AB



### Maximum ratings( $T_j=25^{\circ}C$ , Unless otherwise specified)

Parameter	Symbol	Test Condition	Value	Unit
Drain to Source Voltage	$V_{DS,max}$	$V_{GS}=0V, I_D=500\mu A$	650	V
Gate to Source Voltage	$V_{GS,max}$	Absolute Maximum Values	-8/+20	V
Recommended Operation Voltage of Gate to Source	$V_{GS,op}$	Recommended Operational Values	-5...0/+15	V
Continuous Drain Current	$I_D$	$V_{GS}=15V, TC=25^{\circ}C$	17	A
		$V_{GS}=15V, TC=100^{\circ}C$	12	A
Pulsed Drain Current	$I_{D(pulsed)}$	$V_{GS}=15V, TC=25^{\circ}C$	43	A
Power Dissipation	$P_{tot}$	$TC=25^{\circ}C, T_j=175^{\circ}C$	75	W
Operating and Storage Temperature	$T_j, T_{stg}$	—	-55 to+175	$^{\circ}C$
Solder Temperature, 1.6mm from case for 10s	$T_L$	—	260	$^{\circ}C$



### Thermal Characteristics

Parameter	Symbol	Value			Unit
		Min	Typ	Max	
Thermal Resistance from Junction to Case	$R_{\theta JC}$	—	2	—	$^{\circ}C/W$

### Electrical Characteristics

#### Static Characteristics

Parameter	Symbol	Test Condition	Value			Unit
			Min	Typ	Max	
Gate Threshold Voltage	$V_{GS(th)}$	$V_{GS}=V_{DS}, I_D=2mA, T_j=25^{\circ}C$	2.4	3.2	4	V
		$V_{GS}=V_{DS}, I_D=2mA, T_j=175^{\circ}C$	—	2.4	—	V
Drain to Source Breakdown Voltage	$V_{(BR)DSS}$	$V_{GS}=0V, I_D=500\mu A$	650	—	—	V
Zero Gate Voltage Drain Current	$I_{DSS}$	$V_{GS}=0V, V_{DS}=650V, T_j=25^{\circ}C$	—	—	10	$\mu A$
Gate to Source Leakage Current	$I_{GSS+}$	$V_{GS}=20V, V_{DS}=0V, T_j=25^{\circ}C$	—	—	50	nA
	$I_{GSS-}$	$V_{GS}=-8V, V_{DS}=0V, T_j=25^{\circ}C$	—	—	-50	nA
Drain to Source on Resistance	$R_{DS(on)}$	$V_{GS}=15V, I_D=7A, T_j=25^{\circ}C$	—	190	268	$m\Omega$
		$V_{GS}=15V, I_D=7A, T_j=175^{\circ}C$	—	230	—	$m\Omega$
		$V_{GS}=18V, I_D=7A, T_j=25^{\circ}C$	—	160	220	$m\Omega$
		$V_{GS}=18V, I_D=7A, T_j=175^{\circ}C$	—	200	—	$m\Omega$
Transconductance	$g_{fs}$	$V_{DS}=20V, I_{DS}=7A, T_j=25^{\circ}C$	—	6.2	—	S
		$V_{DS}=20V, I_{DS}=7A, T_j=175^{\circ}C$	—	5.6	—	S



### Electrical Characteristics

#### Dynamic Characteristics

Parameter	Symbol	Test Condition	Value			Unit
			Min	Typ	Max	
Input Capacitance	$C_{iss}$	VGS=0V, VDS=400V, f=1MHz, VAC=25mV	—	448	—	pF
Output Capacitance	$C_{oss}$		—	44	—	pF
Reverse Transfer Capacitance	$C_{rss}$		—	2.2	—	pF
Reverse Transfer Capacitance	$E_{oss}$	VGS=0/15V, VDS=400V, ID=7A, Tj=25°C	—	2.8	—	μJ
Gate-Source Charge	$Q_{gs}$		—	4.6	—	nC
Gate-Drain Charge	$Q_{gd}$		—	3.8	—	nC
Total Gate Charge	$Q_g$	VAC=25mV, f=1MHz	—	12.6	—	nC
Gate Resistance	$R_g$		—	7	—	Ω

#### Switching Characteristics

Parameter	Symbol	Test Condition	Value			Unit
			Min	Typ	Max	
Turn-On Delay Time	$t_{d(on)}$	VGS=0/15V, VDD=400V, ID=7A, RG(ext)=2.5Ω, RL=80Ω	—	11	—	ns
Rise Time	$t_r$		—	8.6	—	ns
Turn-Off Delay Time	$t_{d(off)}$		—	18.2	—	ns
Fall Time	$t_f$		—	14.6	—	ns
Turn-On Switching Energy	$E_{on}$	VDS=400V, VGS=0V/15V ID=7A, RG(ext)=2.5Ω, L=100μH	—	24	—	μJ
Turn-Off Switching Energy	$E_{off}$		—	16	—	μJ

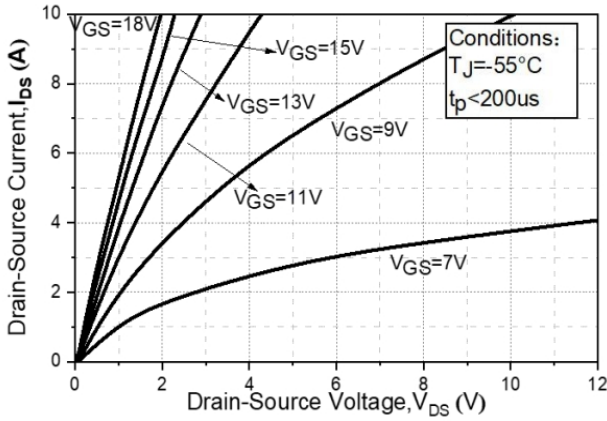
#### Reverse Diode Characteristics

Parameter	Symbol	Test Condition	Value			Unit
			Min	Typ	Max	
Diode Forward Voltage	$V_{SD}$	VGS=-5V, ISD=3.5A, Tj=25°C	—	4.7	—	V
		VGS=-5V, ISD=3.5A, Tj=175°C	—	3.6	—	V
Continuous Diode Forward Current	$I_S$	VGS=0V, Tj=25°C	—	—	16	A
Reverse Recovery Time	$t_{rr}$	VGS=0V, ISD=3.5A, VR=400V, Tj=25°C	—	12	—	ns
Reverse Recovery Charge	$Q_{rr}$		—	28	—	nC
Peak Reverse Recovery Current	$I_{rrm}$		—	1.8	—	A

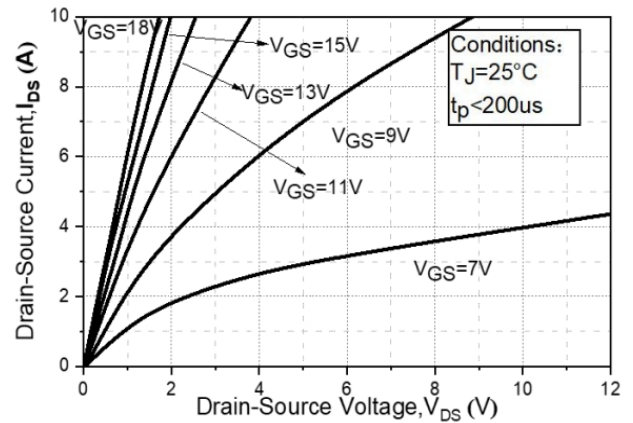


**Typical Performance**

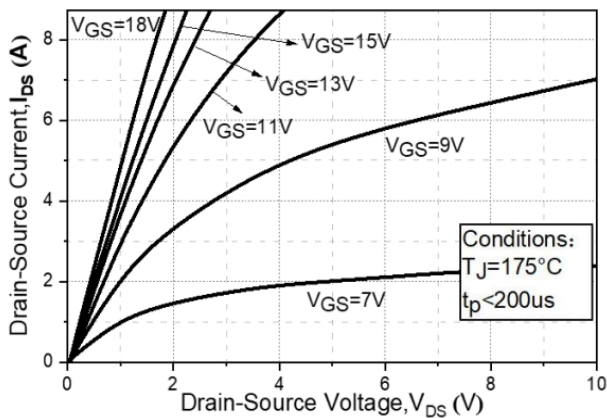
**Fig1. Output Characteristics  $T_J = -55^\circ\text{C}$**



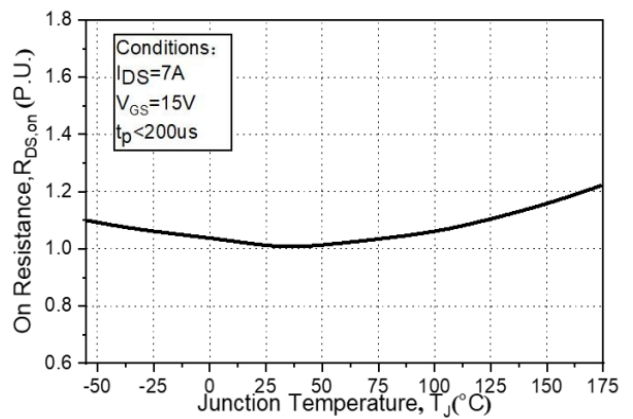
**Fig2. Output Characteristics  $T_J = 25^\circ\text{C}$**



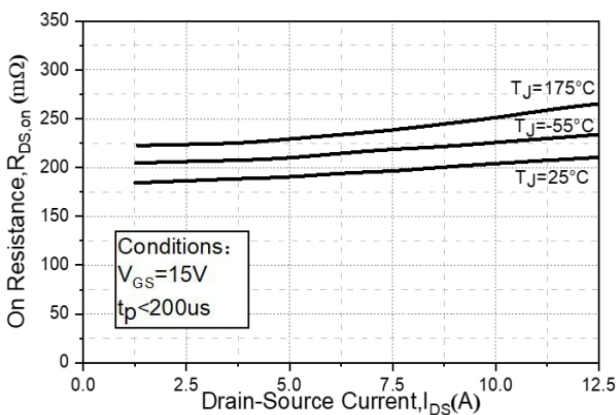
**Fig3. Output Characteristics  $T_J = 175^\circ\text{C}$**



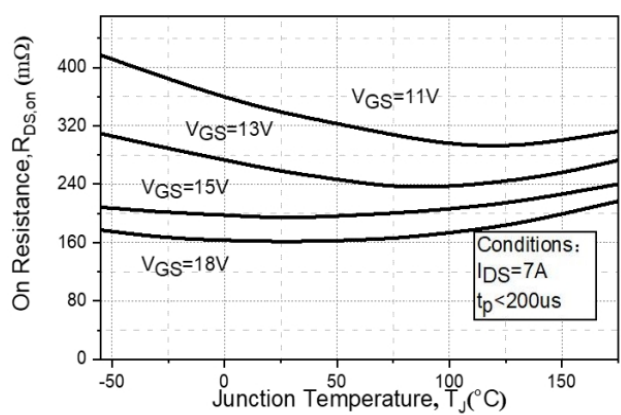
**Fig4. Normalized On-Resistance vs. Temperature**



**Fig5. On-Resistance vs. Drain Current For Various Temperatures**

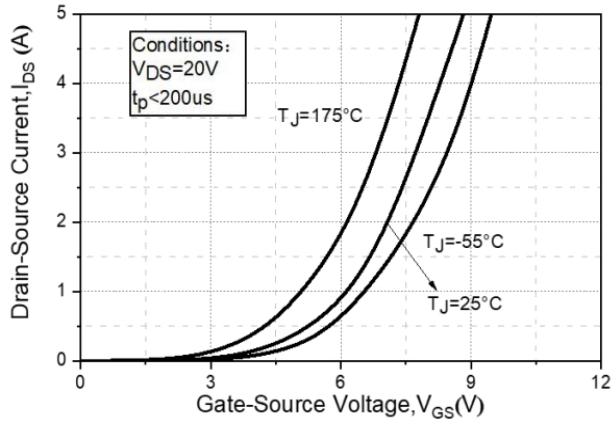


**Fig6. On-Resistance vs. Temperature For Various Gate Voltage**

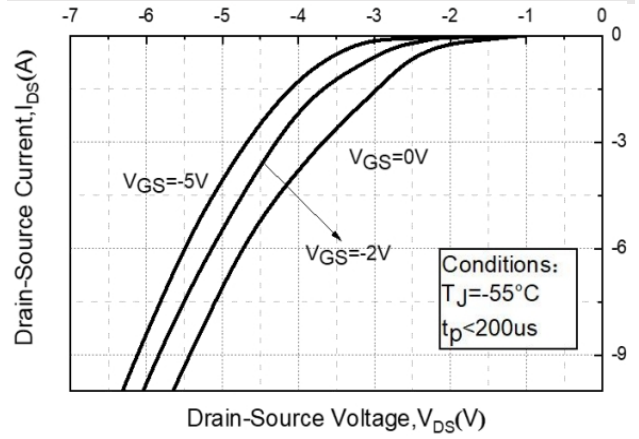


**Typical Performance**

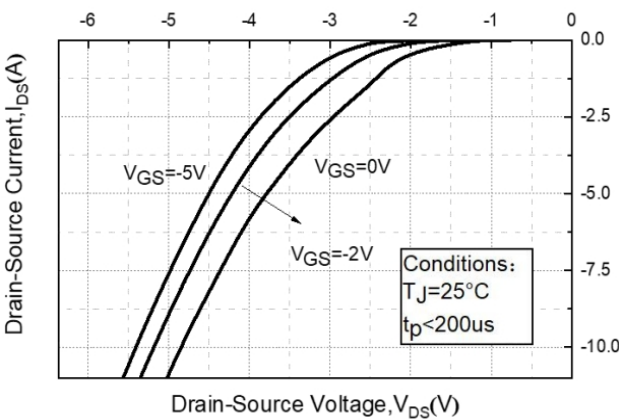
**Fig7. Transfer Characteristic for Various Junction Temperatures**



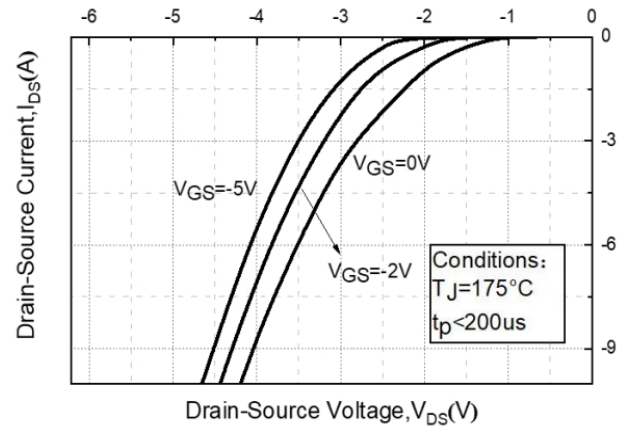
**Fig8. Body Diode Characteristic at -55°C**



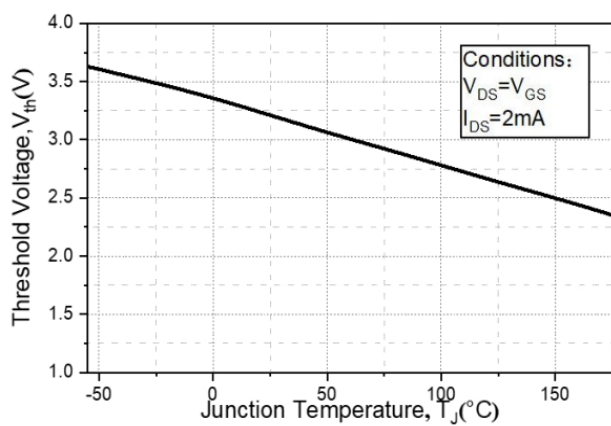
**Fig9. Body Diode Characteristic at 25°C**



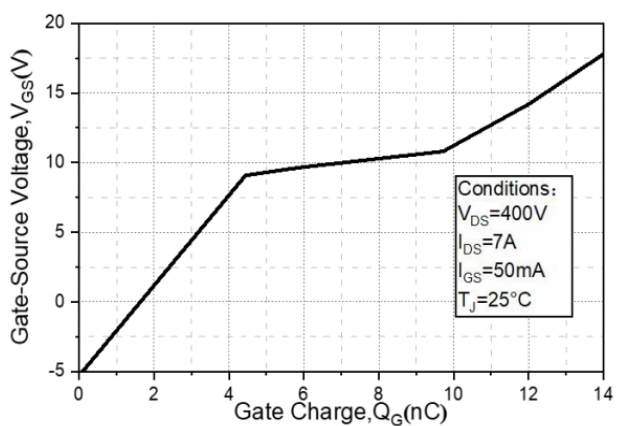
**Fig10. Body Diode Characteristic at 175°C**



**Fig11. Threshold Voltage vs. Temperature**

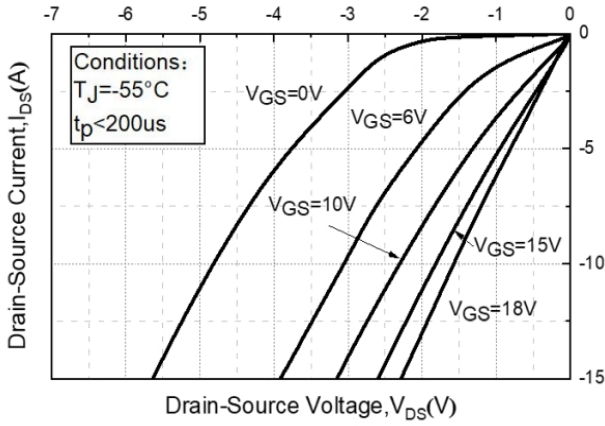


**Fig12. Gate Charge Characteristics**

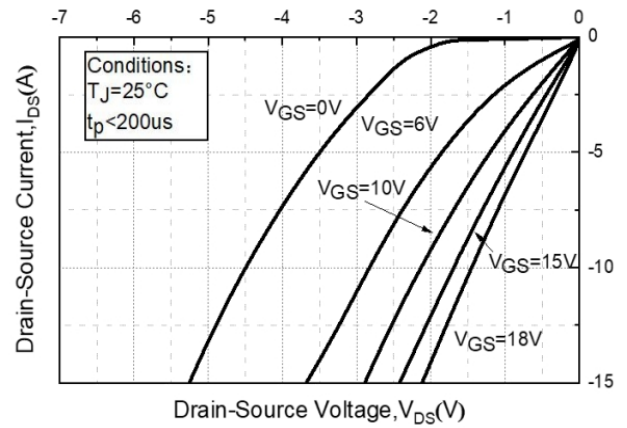


**Typical Performance**

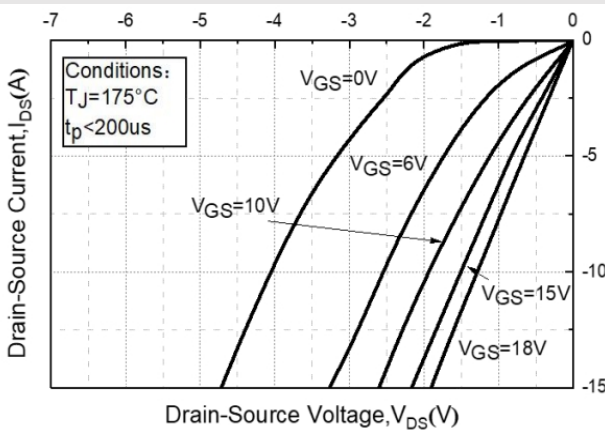
**Fig13. 3rd Quadrant Characteristic at -55°C**



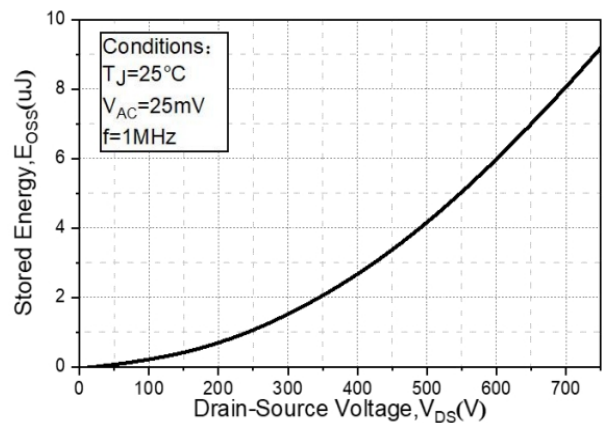
**Fig14. 3rd Quadrant Characteristic at 25°C**



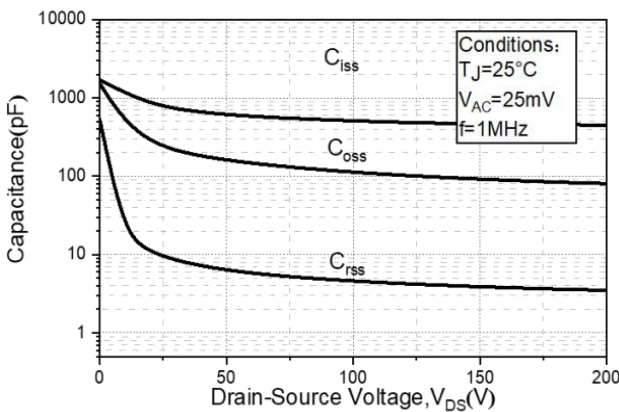
**Fig15. 3rd Quadrant Characteristic at 175°C**



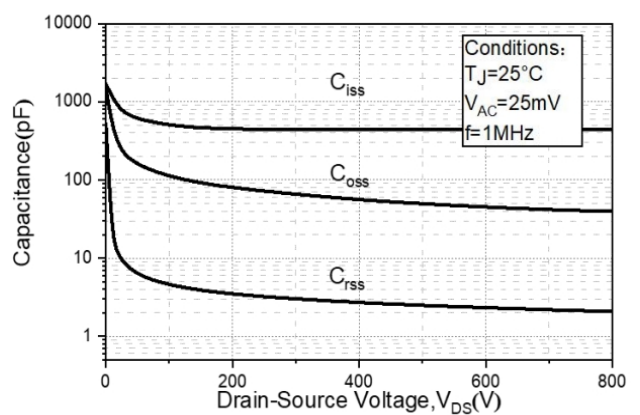
**Fig16. Output Capacitor Stored Energy**



**Fig17. Capacitances vs. Drain-Source Voltage (0-200V)**



**Fig18. Capacitances vs. Drain-Source Voltage (0-800V)**



### Typical Performance

Fig19. Continuous Drain Current vs. Case Temperature

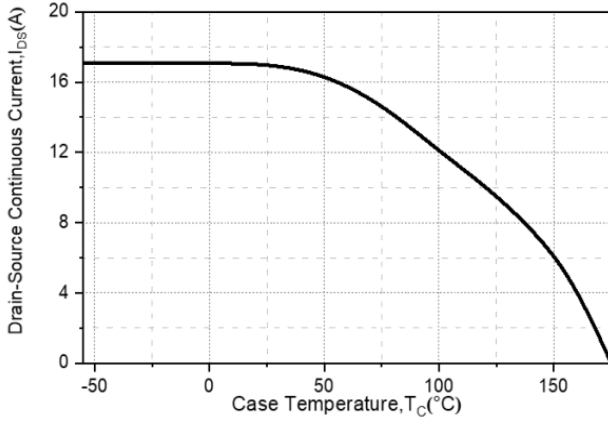
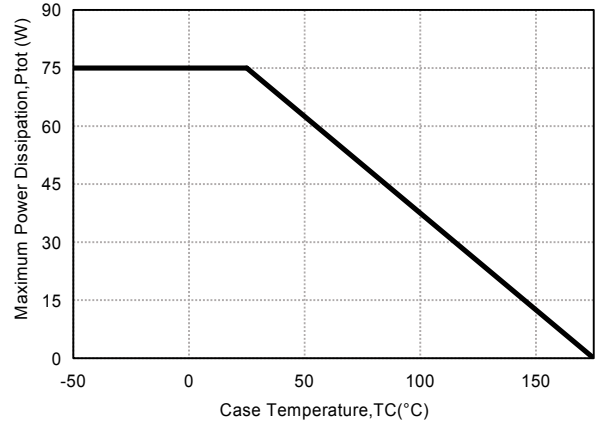
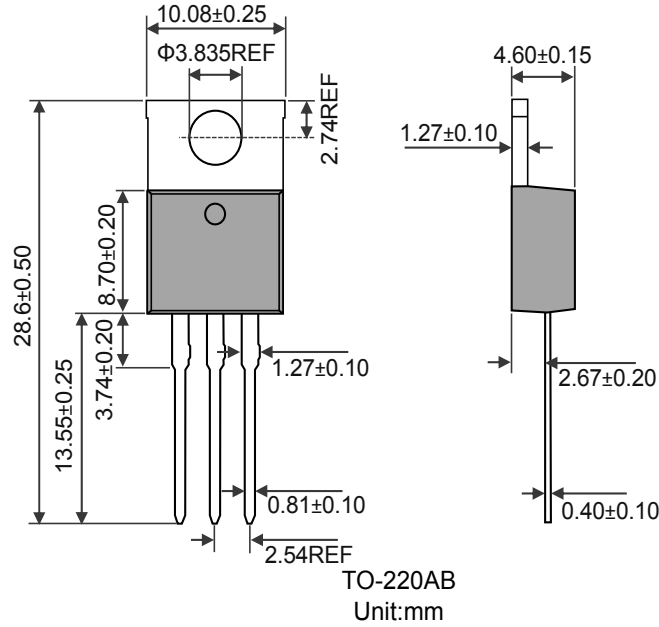


Fig20. Maximum Power Dissipation vs. Case Temperature



**Package Outline Dimensions**



**Marking Information**



“MHCHXM”= Product Logo  
 “Marking Code”= The Following  
 “XXXX”= Date Code Marking

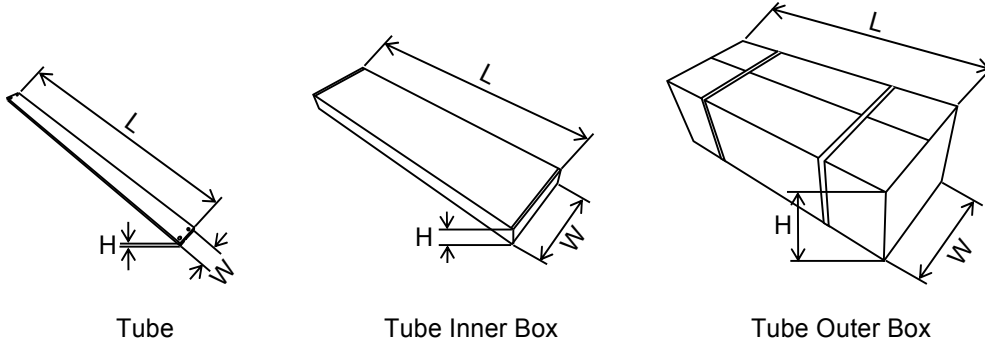
Marking Code	Part Number
C65N160H3	HXMC65N160H3



### Packing Information

Packaging	Part Number	Quantity(pcs)	Size(mm)
Tube	Tube	50	L534×W33×H7
	Inner Box	1000	L560×W150×H40
	Outer Box	5000	L580×W235×H175

#### Packaging:Tube



### Notes

#### Lead Forming

1. During lead frame bending, the lead frame should be bent at a distance more than 3mm from bottom of the epoxy. And the bending degree should not exceed 90°.

Note: The lead frame must be secured and do not touch the epoxy before bending to avoid damage to the transistor. In addition, when using a mold for a large number of lead molding, the structure of the fixed lead must be set, and it should be noted that the lead pressure rod structure cannot exert pressure on the epoxy resin body.

2. Do not bend the lead repeatedly. Do not bend the lead outward



### Heat sink mounting

For power devices, in order to reduce junction temperature, heat dissipation blocks are usually used to disperse heat to the outside, and semiconductor power devices installed on the heat dissipation blocks can effectively dissipate heat without losing the reliability of the semiconductor, so the following matters should be noted when using:

1. Pay attention to the selection of silicone cream

In order to improve the thermal conductivity and heat dissipation effect of the device and the heat dissipation block, generally apply a thin layer of silicone grease evenly on the contact surface of the device and the heat dissipation block. Choose a silicone grease with low oil separation degree. Do not overapply it, otherwise it will attach too much stress to the resin.

2. Optimum torque is required

When using the fastening torque, pay attention not to use too much torque, so as not to damage the epoxy resin body, pay attention to the smooth cooling block body, no file chips and other foreign bodies between the transistor and the cooling block, pay attention to the selection of screws, nuts, gaskets and washers, so as not to cause damage to the transistor due to improper selection.

### Soldering

1. Pay special attention to welding. When welding, the distance between the solder joint and the epoxy ball should be greater than 3mm, and it is recommended to weld it outside the tie rod base.

2. Avoid applying any pressure to the lead frame while the transistor is at high temperatures, especially when welding. Dip welding and manual welding should not be done more than once

### Notes:

For specific precautions, please refer to our company's relevant technical documents or visit our official website at <http://www.jshxm.com>



## DISCLAIMER

1. Above specification may be changed without notice. MHCHXM will reserve authority on material change for above specification.
2. The graphs shown in this datasheet are representing typical data only and do not show guaranteed values.
3. When using this product, please observe the absolute maximum ratings and the instructions for use outlined in these specification sheets. MHCHXM assumes no responsibility for any damage resulting from use of the product which does not comply with the absolute maximum ratings and the instructions included in these specification sheets.
4. These specification sheets include materials protected under copyright of MHCHXM. Reproduction in any form is prohibited without the specific consent of MHCHXM.
5. This product is not intended to be used for military, aircraft, automotive, medical, life sustaining or life saving applications or any other application which can result in human injury or death. Please contact authorized MHCHXM sales agent for special application request.
6. Statements regarding the suitability of products for certain types of applications are based on MHCHXM's knowledge of typical requirements that are often placed on MHCHXM products in generic applications. Such statements are not binding statements about the suitability of products for a particular application. It is the customer's responsibility to validate that a particular product with the properties described in the product specification is suitable for use in a particular application. Parameters provided in datasheets and/or specifications may vary in different applications and performance may vary over time. All operating parameters, including typical parameters, must be validated for each customer application by the customer's technical experts. Product specifications do not expand or otherwise modify MHCHXM's terms and conditions of purchase, including but not limited to the warranty expressed therein.
7. This publication supersedes & replaces all information previously supplied. For additional application information, please visit our website <http://www.jshxm.com>, or consult your nearest MHCHXM's sales office for further assistance.

